



Surface Finishing Tools & Accessories



High-performance Tools for
Finishing Stainless Steel, Steel,
Nonferrous Metals and Wood

GRINDING **BLENDING**
SANDING **POLISHING**
DEBURRING **BEVELING**

 **UNITEC**

ELECTRIC • PNEUMATIC • HYDRAULIC
... the power of innovation!®

UNITEC Surface Finishing Tools & Accessories

The value is in the engineering... the payback is in the performance.™

CS Unitec offers professional power tools and abrasive accessories for surface finishing on **STEEL, STAINLESS STEEL, ALUMINUM** and other metals, as well as rigid plastics and wood.

Innovation is the engine of efficiency!™

Innovations in machine design, abrasive materials and production methods have led the way to:

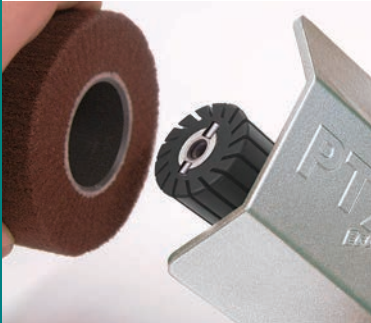

Hollow-core abrasives for linear grinding

The PTX Eco Smart is a surface finishing machine with a finned shaft for quick abrasive changing – simply slide on the abrasives and they secure automatically. This saves time and the abrasive wheels cost less. (Patented!)



5/8"-11 SPEED NUT changeover

The **EASY-LOCK SPEED NUT** allows you to change flap discs in seconds, without tools. It is easily hand tightened and eliminates the need for wrenches or expensive hubs. (Patented!)

Belts with buttonhole fastening system for grinding and polishing closed pipe constructions. (Patented!)



Important advancements in flap disc technology

- PLANTEX® high-tech hemp fiber compound (Patented!)
- POLY-MAGIC-WHEEL for dry polishing inside corners
- MAGNUM® FLEECE TOP for surface conditioning, fine finishing and polishing



Hemp fiber is an almost ideal base material for backing plates of flap discs... and it is a renewable resource!

Safer and more efficient!

CS Unitec is the source for flap discs and abrasives that are free of fiberglass, mineral fibers and epoxy resin. They offer superior material removal, longer service life and smoother ergonomic handling.

Better for the environment!

The fiber in the high-tech PLANTEX® compound is derived from the hemp plant – a sustainable raw material which counteracts greenhouse emissions as it grows. The PTX hollow-core abrasives not only improve production efficiencies, but also minimize pollution from production to waste disposal... no plastic insert!



Better for your bottom line!

In addition to their time-saving features and high quality, flap discs and abrasives from CS Unitec can save you money – their cost of production is lower, their quality is among the best and they offer superior service life. Hollow-core abrasive wheels from CS Unitec are more affordable than traditional solid-core abrasives since they can be produced from less raw material. These new hollow-core abrasive wheels can also be used on traditional finishing machines with the aid of a simple core adapter (see page 5).



View product demonstrations at www.csunitec.com.

Surface Finishing Tools and Abrasives Index:

Surface Finishers		p. 4-11
PTX Eco Smart – electric		p. 4-6
LP 1503 AIR – pneumatic		p. 6
Abrasives, Belts, Brushes, Grinding Wheels, etc.		p. 7-11
Multipurpose Grinders		p. 12-13
MULTI-MAX Stationary Multipurpose Grinder		p. 12-13
Flexible Shaft - flexible drive shaft for use with VARILEX® and MULTI-MAX		p. 13
All-in-One Angle Grinder/Finishing, Blending & Polishing Machine		p. 14-15
VARILEX® Speed-controlled Grinder/Finisher/Polisher – 4" to 7" diameter		p. 14-15
Flap Discs, Blending, Finishing and Reduced Sparking Discs		p. 16-29
PLANTEX® – for blending steel and stainless steel		p. 18-20
PLANTEX® COOL TOP – for blending stainless steel		p. 20
PLANTEX® CERAMIC – for the highest performance blending of all metals		p. 21
PLANTEX® TIGER SHARK® – for blending aluminum		p. 22
FIX HOOK & LOOP SYSTEM – flexible backing disc for finishing		p. 23-25
POLY-MAGIC-WHEEL – for dry polishing in corners		p. 26
MAGNUM® TOPMIX – for increased material removal		p. 26
MAGNUM® FLEECE TOP – for conditioning, finishing and polishing		p. 27
MAGNUM® CLEAN – for pore-deep cleaning of metals		p. 27
EB Diamond Grinding and Cutting Discs – for reduced sparking		p. 28-29
Pipe Sanders		p. 30-31
PIPE-MAX – weld seam grinder and pipe sander		p. 30
BOA LRP 1503 – for polishing handrails, pipe and tubing; electric or pneumatic		p. 31
Angle Grinders, Sanders and Polishers		p. 32-34
LBS 1105 VE – finger belt sander for angles, corners, pipes and curves		p. 32
GLADIUS® 1800 Multifunctional Grinder		p. 33
Angle Grinders, Sanders – air and electric/dust extraction		p. 34
Dust Collection Vacuums		p. 35
Dust Collection Vacuums – with HEPA filtration		p. 35
Deburring, Beveling and Faceting Machines		p. 36-41
Sheet Metal Deburring, Beveling and Faceting Machines		p. 36-39
Portable Beveling Machines		p. 40-41
Trelawny™ Surface Preparation Equipment		p. 42
Air and electric tools for preparation of concrete, steel and stone		p. 42
Magnetic Drills and Dry Cutting Circular Saws		p. 43
Magnetic drills and dry cutting circular saws for metal		p. 43



PTX ECO SMART



PLANTEX®



VARILEX®

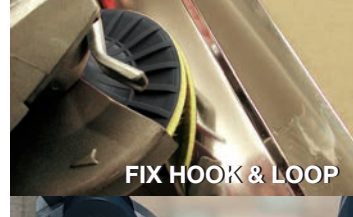

FIX HOOK & LOOP



BOA PIPE SANDER



ANGLE GRINDERS WITH DUST EXTRACTION



DEBURRING



BEVELING

Safety Guidelines

Use all products according to the safety regulations of OSHA and directives by ANSI (American National Safety Institute) B7.1, European DIN EN 13743 and all other applicable international safety standards.

PTX ECO SMART

The professional surface finisher for hard, continuous use.

A revolution in linear grinding! Simply slide on the abrasives and they secure themselves automatically when the machine turns. Fast and easy!

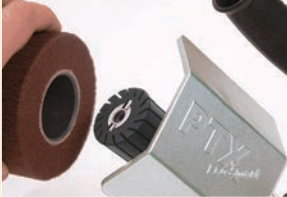

Press the spindle lock and simply slide on the abrasive wheels or brushes, turning in the correct direction onto the finned shaft. They will be secured automatically.



Grinding in corners is easy – simply slide the abrasive wheel on the finned shaft a little towards the outside.



Even narrow abrasive wheels can be used on the PTX Eco Smart and positioned freely on the finned shaft (no spacer rings required).



1 Adjustable handle suitable for right and left-handed users. Anti-vibration handle for comfortable, fatigue-free working.



2 Simple speed control during operation. Stable speed thanks to tachogenerator.



3 QUICK-LOCK cable for fast, easy replacement if cable is damaged. 13 ft., included.



4 Infinitely adjustable cover guard with securing points for the extraction cover. **Part Number: 40005**



5 Extended polycarbonate cover guard for grinding wheel widths up to 6". **Part Number: 52706**



6 Hollow core shaft adapter for roller wheel widths up to 6" and vibration-free operation. **Part Number: 42004**



PTX Eco Smart



110 Volt or 220 Volt

Perfect finishes on large surfaces, with no shadows or streaks.



New abrasive mounting system saves time, reduces cost and eliminates vibration.

PTX Eco Smart is a multi-functional grinding and polishing system for flat surfaces and open or closed pipe constructions. It grinds from coarse to very fine finishes and burnishes to a high-gloss finish. It enhances stainless steel, steel and nonferrous metals including aluminum, brass, bronze and copper, as well as wood and rigid plastic.

Balanced straight-line handling, high torque and electronic speed control enable the PTX to easily produce matte, satin and other decorative surfaces up to a mirror finish. Besides fine finishing, the PTX is ideal for coarse grinding to remove welds, deep scratches, oxidation, rust and paint.

PTX Eco Smart features a newly developed abrasive mounting system. This unique system allows grinding and polishing wheels to be changed in seconds, without tools or hardware. Simply slide the wheels and accessories onto the finned, rigid rubber shaft. They secure themselves automatically when the machine turns.

The finned shaft design ensures absolutely no vibrations during operation and 100% concentricity. The main savings compared to other linear grinders comes from the cost of abrasives. The elimination of an internal core means the abrasive wheels can be produced less expensively, while delivering the same high-quality results.

CS Unitec can provide you with an extensive range of abrasive tools and accessories to cover almost every conceivable surface finishing application.



Satin finishing using interleaf fleece wheel.



A wide selection of hollow-core abrasives is available for the PTX Eco Smart. The lack of a core insert means that the abrasives are lighter, easier to use and less expensive.

NOTE: We do continue to carry abrasives with core insert adapters for older LP 1503 VR model grinders and other machines. Contact us for more information.

PTX Eco Smart Specifications

Order Number: **PTX ECO SMART**

Power	15 Amp (1710 Watts) 110 Volt / 60 Hz <small>(Also available: 230 Volt / 50 Hz)</small>	
Speed Control Dial	Variable speed control from 1000 to 3800 RPM with tachogenerator for constant speed, even under load	
Wheel Width	2", 4" or 6" wide abrasives	
Wheel Diameter	up to 4-1/2"	
Weight	7.25 lbs.	
Standard Equipment	4" Interleaf (combi) wheel – P/N 47312 Shaft Adapter – P/N 42004	

Accessories

Hollow-core Shaft Adapter

Allows user to utilize more economical hollow-core abrasives on traditional surface finishers. Fits 3/4" dia. x 4" long shaft and 1/4" keyway(s). Overall diameter of adapter is 1-3/4" (45mm)
Part Number: 42004



A range of professional PTX Eco Smart kits is available for a variety of applications. See page 6 for more information.

The PTX Bench Grinder – MULTI-MAX

Multipurpose sander with two shaft mountings for grinding discs, angle grinders and grinding rollers for longitudinal grinders. Uses all PTX abrasive wheels and discs. (See page 12 for more details.)



Pneumatic Surface Finisher

Save time sanding and polishing. 4" wide face is ideal for finishing stainless steel, metals, wood and synthetics.

The powerful LP 1503 AIR grinding and polishing machine produces a uniform finish fast and easy without leaving visible transitions and shadows. It is compact, lightweight and heavy duty. Ideal for graining, polishing, brushing, blending, deburring, cleaning welds, roughing and more. Easily achieve a #3, #4, #6 or #8 finish. Constant speed, high torque and a comprehensive line of accessories make this an essential tool for surface finishing.

Pneumatic Surface Finisher Specifications

Order Number: LP 1503 AIR

Load Speed	2500 RPM
Motor	1 HP (1/2" Air Connection)
Air Consumption	20 CFM @ 90 PSI
Wheel Diameter	up to 4-1/2"
Weight	8 lbs.
Standard Equipment	4" Interleaf (combi) wheel – P/N 47312 Shaft Adapter – P/N 42004



1 HP air motor at 90 PSI

PTX Eco Smart Kits

PTX Professional Kit For Metalworking

This set comes in a strong, impact-resistant transport case and contains everything you need for shadow-free industrial finishes. Match or create any finish up to a mirror finish on metals. Prevent marks and fingerprints with newly developed cleaning products and preservatives. **Part Number 47004A**



PTX Professional Kit for Metalworking includes:

- 1 PTX Eco Smart machine
- 1 Professional Case (P/N 80002)
- 1 40 grit flap wheel, 4" x 4-1/8" (P/N 47211)
- 1 80 grit interleaf (combi) wheel, 4" x 4-1/8" (P/N 47312)
- 1 Expansion roller, 3-1/2" x 4" (P/N 47005)
- 2 80 grit grinding belt sleeve, 3-1/2" x 4" (P/N 42080)
- 1 Fine fleece (Nonwoven) sleeve, 3-1/2" x 4" (P/N 42012)
- 1 Medium fleece (Nonwoven) sleeve, 3-1/2" x 4" (P/N 42011)
- 2 A45 TZ Pyramid sleeves, 3-1/2" x 4" (P/N 42245)
- 2 A30 TZ Pyramid sleeves, 3-1/2" x 4" (P/N 42230)
- 2 A16 TZ Pyramid sleeves, 3-1/2" x 4" (P/N 42216)
- 2 A06 TZ Pyramid sleeves, 3-1/2" x 4" (P/N 42206)
- 3 SuperPolish sleeves, 3-1/2" x 4" (P/N 42013N)
- 1 Belt driving roller (P/N 47006)
- 2 80 grit grinding belts, 1.2" x 24" (P/N 49080)
- 1 Medium fleece (Nonwoven) belt, 1.2" x 26" (P/N 49002)
- 2 A45 TZ Pyramid belts, 1.2" x 24" (P/N 49345)
- 2 A30 TZ Pyramid belts, 1.2" x 24" (P/N 49330)
- 2 A16 TZ Pyramid belts, 1.2" x 24" (P/N 49316)
- 2 A06 TZ Pyramid belts, 1.2" x 24" (P/N 49306)
- 3 SuperPolish belts, 1.2" x 26" (P/N 49004N)
- 1 Mini high gloss polishing paste, pink (P/N 40015T)
- 2 Mini polishing pastes, white and blue [P/N 40013 (white) P/N 40014 (blue)]
- 1 PTX lime scatter can (P/N 40020A)
- 5 Microfiber cloths (P/N 40031)
- 1 Brilliance clean spray bottle (P/N 40050)
- 1 INOX-protect spray bottle (P/N 40040)

PTX Basic Kit for Metal

Basic set for coarse finishing to #4 finish on flat surfaces and pipes.

Part Number 47003A



PTX Basic Kit for Metal includes:

- 1 PTX Eco Smart machine
- 1 Carrying Case (P/N 40008)
- 1 60 grit flap wheel, 4" x 4-1/8" (P/N 47212)
- 1 80 grit interleaf (combi) wheel, 4" x 4-1/8" (P/N 47312)
- 1 Expansion roller, 3-1/2" x 4" (P/N 47005)
- 1 Medium fleece (Nonwoven) sleeve, 3-1/2" x 4" (P/N 42011)
- 1 Belt driving roller (P/N 47006)
- 1 80 grit grinding belt, 1.2" x 24" (P/N 49080)
- 1 Medium fleece (Nonwoven) belt, 1.2" x 26" (P/N 49002)
- 1 40 grit grinding belt, 3.6" x 4" (P/N 42040)
- 1 60 grit grinding belt, 3.6" x 4" (P/N 42060)
- 1 80 grit grinding belt, 3.6" x 4" (P/N 42080)
- 1 120 grit grinding belt, 3.6" x 4" (P/N 42120)

PTX Kit For Woodworking

The complete set for treating wooden surfaces. Strong transport case with PTX Eco Smart and a range of brush wheels for various wood structures. Suction cover for extracting grinding dust particles.

Part Number 40004-3A



PTX Basic Kit for Woodworking includes:

- 1 PTX Eco Smart machine
- 1 Carrying Case (P/N 40008)
- 1 Suction cover (P/N 40005)
- 1 Spacer ring (P/N 40007)
- 1 PTX stranded wire wheel (P/N 46301)
- 1 Bristle wheel (P/N 46101)
- 1 Fiber wheel (P/N 46400)

PTX Grinding Wheels for Coarse and Fine Finishing

PTX abrasives from CS Unitec are made according to high quality standards. A unique production process guarantees high concentricity and thus vibration-free grinding – a prerequisite for fatigue-free working and perfect surface finishes with no transitions or shadows. **Simply try it!** You will be surprised how much smoother a PTX grinding wheel or brush wheel is.



PTX FLEECE (Nonwoven) Wheel

Flexible nylon fleece impregnated with abrasives for a first-class finish. Produces shadow-free matte, satin and polished finishes. For removing oxidation on stainless steel and nonferrous metals and also suitable for smoothing wooden surfaces. Very high fleece content by fleece compression.

Diameter: 4"
Width: 2", 4-1/8" or 6"
Grit: 60, 80, 180, 280, 400, 600



PTX Interleaf (Combi) Wheel

Nylon fleece combined with abrasive flaps for matte finishing, burnishing and removing light scratches, oxidation and handling marks on stainless steel and all metals. For removing old paint on wood while smoothing at the same time.

Diameter: 4"
Width: 2", 4-1/8" or 6"
Grit: 60, 80, 180



PTX Flap Wheel

With radial abrasive cloth flaps in various grit sizes for removing rust, oxidation layers, minor scratches and for the regraining and burnishing of metals.

Diameter: 4"
Width: 2" or 4-1/8"
Grit: 24, 40, 50, 60, 80, 120, 180, 240



PTX CLEAN Wheel

Made of hard-textured, nonwoven fleece for cleaning and descaling welds, pore-deep removal of rust, oxidation and coatings, cleaning beams, bricks, etc. Produces an effective linear finish on stainless steel. A new production process guarantees 100% concentricity.

Diameter: 4"
Width: 2" or 4"
Grit: Medium



PTX GUM Wheel

Soft rubber impregnated with abrasive grit for the removal of minor scratches. Ideal for a bright, decorative linear finish on stainless steel and nonferrous metals and for smoothing wooden fibers.

Diameter: 4"
Width: 2" or 4"
Grit: 60, 180

HOLLOW-CORE ABRASIVES HAVE MANY ADVANTAGES:

- Easy to mount – simply slide on and off
- 100% concentricity – no vibration
- Lower cost and higher productivity!

We continue to carry abrasives with core inserts.
 Contact us for more information.

PTX FLEECE (Nonwoven) Wheels

Part No.	Grit	Size
47411	60 grit	4" dia. x 4-1/8" wide
47412	80 grit	4" dia. x 4-1/8" wide
47413	180 grit	4" dia. x 4-1/8" wide
47414	280 grit	4" dia. x 4-1/8" wide
47415	400 grit	4" dia. x 4-1/8" wide
43601*	600 grit	4" dia. x 4-1/8" wide
47401	60 grit	4" dia. x 2" wide
47402	80 grit	4" dia. x 2" wide
47403	180 grit	4" dia. x 2" wide
47404	280 grit	4" dia. x 2" wide
47405	400 grit	4" dia. x 2" wide
47422	80 grit	4" dia. x 6" extra wide
47423	180 grit	4" dia. x 6" extra wide

* Keyed Shaft

PTX Interleaf (Combi) Wheels

Part No.	Grit	Size
47311	60 grit	4" dia. x 4-1/8" wide
47312	80 grit	4" dia. x 4-1/8" wide
47313	180 grit	4" dia. x 4-1/8" wide
47301	60 grit	4" dia. x 2" wide
47302	80 grit	4" dia. x 2" wide
47303	180 grit	4" dia. x 2" wide
47322	80 grit	4" dia. x 6" extra wide
47323	180 grit	4" dia. x 6" extra wide

PTX Flap Wheels

Part No.	Grit	Size
47211	40 grit	4" dia. x 4-1/8" wide
47212	60 grit	4" dia. x 4-1/8" wide
47213	80 grit	4" dia. x 4-1/8" wide
47214	120 grit	4" dia. x 4-1/8" wide
47215	180 grit	4" dia. x 4-1/8" wide
47201	24 grit	4" dia. x 2" wide
47202	40 grit	4" dia. x 2" wide
47203	50 grit	4" dia. x 2" wide
47204	60 grit	4" dia. x 2" wide
47205	80 grit	4" dia. x 2" wide
47206	120 grit	4" dia. x 2" wide
47207	180 grit	4" dia. x 2" wide
47208*	240 grit	4" dia. x 2" wide

* Keyed Shaft

PTX CLEAN Wheels

Part No.	Grit	Size
47511	Medium (black)	4" dia. x 4" wide
40018A*	Medium (black)	4" dia. x 2" wide

PTX GUM Wheels

Part No.	Grit	Size
250 525-4*	60 grit	4" dia. x 4" wide
45181*	180 grit	4" dia. x 4" wide
45180*	180 grit	4" dia. x 2" wide

* Keyed Shaft



Expansion Roller

Use with sanding belts, fleece and felt sleeves. The sleeves are simply pushed over the expansion roller and held securely in place by the centrifugal force. **3-1/2" dia. x 4" wide - Part Number: 47005**

TIPS & TRICKS

Expansion Roller - Hard Rubber

Internal expansion slots now allow easier sleeve replacement and improved adjustment to the workpiece, as well as vibration absorption and concentricity.

Part Number: 47005



Belt Sleeves for Expansion Roller

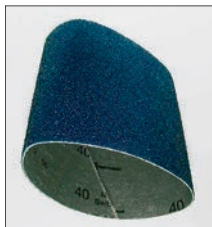

PTX Zirconium Grinding Belt Sleeve

Made of zirconium. Removes deep scratches and grinds weld seams on metals. Far less rework is required as a result of using the time-saving linear grinding technique.

3-1/2" dia. x 4" wide
Grit: 40, 60, 80, 120, 150, 180

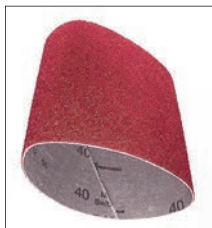

PTX Ceramic Grinding Belt Sleeve

High-performance ceramic aluminum oxide grain. Increased removal rate and longest life for highest productivity. Excels in all metals.

3-1/2" dia. x 4" wide
Grit: 40, 60, 80

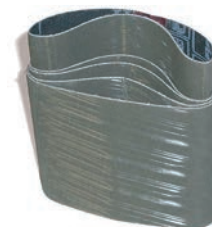

PTX TZ Pyramid Sleeve

New abrasive cloth with pyramid-shaped grit structure. Allows high material removal while producing a very fine finish, reducing the amount of work required when compared to grinding belt sleeves and fleece sleeves. Pyramid sleeves are ideal for pre-polishing for fine mirror finishes and for removing scratches and spot welds. Even roller scale can be removed easily.

3-1/2" dia. x 4" wide
Grit: A65/320, A45/400, A30/600, A16/1200, A06/2000



PTX Fleece "Nonwoven" Sleeve

Nylon impregnated with abrasive grit for removing minor to medium scratch marks and oxidation coatings, matte and satin finishing and deburring applications.

3-1/2" dia. x 4" wide
Grit: Coarse, Medium, Fine, Superfine

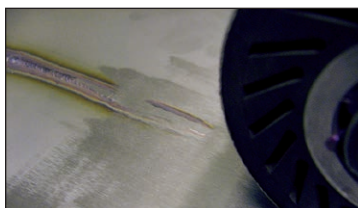

The expansion roller is helpful when grinding large areas and removing large welds.

PTX Zirconium Grinding Belt Sleeves

Part No.	Grit	Size (dia. x width)	Quantity
42040	40 grit	3-1/2" x 4"	10 per pack
42060	60 grit	3-1/2" x 4"	10 per pack
42080	80 grit	3-1/2" x 4"	10 per pack
42120	120 grit	3-1/2" x 4"	10 per pack
42150	150 grit	3-1/2" x 4"	10 per pack
42180	180 grit	3-1/2" x 4"	10 per pack

PTX Ceramic Grinding Belt Sleeves

Part No.	Grit	Size (dia. x width)	Quantity
42440	40 grit	3-1/2" x 4"	10 per pack
42460	60 grit	3-1/2" x 4"	10 per pack
42480	80 grit	3-1/2" x 4"	10 per pack

PTX TZ Pyramid Sleeves

Part No.	Grit	Size (dia. x width)	Quantity
42265	A65/320 grit	3-1/2" x 4"	10 per pack
42245	A45/400 grit	3-1/2" x 4"	10 per pack
42230	A30/600 grit	3-1/2" x 4"	10 per pack
42216	A16/1200 grit	3-1/2" x 4"	10 per pack
42206	A06/2000 grit	3-1/2" x 4"	10 per pack

TZ PYRAMID GRIT COMPARISON TABLE

Corresponds to grit size	A65	A45	A30	A16	A06
	320	400	600	1200	2000

PTX Fleece "Nonwoven" Sleeves

Part No.	Grit	Size (dia. x width)	Quantity
42010	coarse (brown)	3-1/2" x 4"	5 per pack
42011	medium (red)	3-1/2" x 4"	5 per pack
42012	fine (blue)	3-1/2" x 4"	5 per pack
42009	superfine (grey)	3-1/2" x 4"	5 per pack

FLEECE COMPARISON TABLE

Corresponds to grit size	Coarse (brown)	Medium (red)	Fine (blue)	Superfine (grey)
	80	180	280	400

TIPS & TRICKS



To remove the grinding sleeve, place the expansion roller on a round object that is slightly smaller than the roller. Then push the sleeve down slightly using both hands.

Special Brushes for Metals, Wood and Hard Plastics



PTX Stranded Wire Wheels
 Sturdy steel wire brush. For deburring, rust removal, roughing and cleaning metal. For brushing out soft annual rings on timber, leaving a rough rustic effect.
 4" dia. x 2-7/8" wide – **Part No. 46301***
 4" dia. x 1" wide – **Part No. 47702***
 * Requires spacer rings 40007



PTX Bristle Wheel
 Elastic nylon brush impregnated with abrasive grit. For roughing and deburring metal, as well as creating a rustic effect with even annual ring transitions on timber.
 4" dia. x 2-7/8" wide – **Part No. 46101***
 4" dia. x 1" wide – **Part No. 46102N***
 * Requires spacer rings 40007



PTX Stainless Steel Wire Wheels
 Elastic stainless steel wire brush. For cleaning welds, deburring, removing rust, roughing and removing coatings.
 4" dia. x 2-7/8" wide – **Part No. 251 625***
 4" dia. x 1" wide – **Part No. 46202N***
 * Requires spacer rings 40007



PTX Fiber Wheel
 Elastic fiber brush. For polishing stained wood, satin finishing, pore-deep dust removal and cleaning applications.
 4" dia. x 4" wide – **Part No. 46400**

Note: Above wheels are configured for keyed shaft. Hollow-core shaft adapter not necessary.

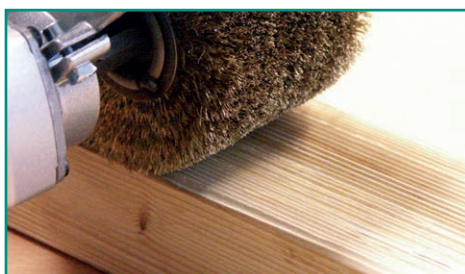

Stranded wire wheel for creating a rustic effect on wood



Cotton Buffing Wheel
 Cotton yarn wheel for use with compounds. Produces a very bright high mirror finish. Use on flat, contoured or irregular surfaces.
 4" dia. x 2" wide
Part No. CS2405*
 4" dia. x 4" wide
Part No. CS2410
 4" dia. x 6" wide
Part No. CS2420
 * Requires spacer rings 40007

Abrasives for Polishing to High-gloss and Mirror Finish



PTX Felt Sleeve
 Made of soft merino (endless) for polishing large stainless steel and nonferrous surfaces quickly to a mirror finish. Also suitable for hard plastics. Must be used with the expansion roller.
 3-1/2" dia. x 4" wide
Part No. 42013



PTX SuperPolish Sleeve
 Revolutionary special fleece produces perfect brilliant, shadow-free mirror finishes on stainless steel and nonferrous metal surfaces using polishing compounds (white and blue) and pink polishing cream. SuperPolish fleece is absorbent, does not smear and saves significant work time. Must be used with the expansion roller.
 3-1/2" dia. x 4" wide
Part No. 42013N



Poly-PTX Cotton Rings
 Fleece rings for polishing narrow or uneven stainless steel and nonferrous metal surfaces using polishing compounds (white and blue) and pink polishing cream. A separate Poly-PTX Cotton Ring must be used for each compound or cream so as not to mix different compound grits.
 For polishing narrow or uneven stainless steel surfaces:
 100mm x 12mm (4" dia. x 1/2" wide), 8 per pack **Part No. 40019M**
 For polishing aluminum, brass and other nonferrous metals:
 100mm x 12mm (4" dia. x 1/2" wide) **Part No. 250 521**

See page 10 for pre-grinding and polishing compounds, mirror finish creams, cleaners and protective sprays for finished metal surfaces.



Polishing and Maintenance Products (cont'd)



PTX Pre-grinding & Polishing Compound
Essential for polishing all metals, including stainless steel, aluminum, etc.

PTX® WHITE pre-polishing compound (23 oz.) – **Part No. 40013**
PTX® BLUE finishing compound (23 oz.) – **Part No. 40014**
PTX® WHITE and BLUE mini pastes (approx 4.2 oz. ea.) – **Part No. 40009**



PTX Polishing Cream, Pink

For high reflective finishing. Produces a perfect mirror finish on stainless steel and nonferrous metals when used with the SuperPolish Sleeve.

Miniature tube, 2 oz. – Part No. 40015T
Can, 2.2 lbs. – Part No. 40015



PTX Lime (noncaustic)

For removing cream and compound residues. Scatter on the surface, and wipe off with a microfiber cloth.

Aluminum scatter container with Lime (approx 5.3 oz.) – **Part No. 40020A**
Can, 2.2 lbs. – Part No. 40016
Scatter container only – Part No. 40020



Microfiber Cloths

For pore-deep cleaning and even distribution of maintenance products and polishes. Our microfiber cloths produce a top finish on all materials.

Size: 13" x 14" – Part No. 40031



INOX-Protect (hard sealant)

Protects finished and polished metal surfaces (stainless steel, steel, aluminum, brass, copper, etc.) with a clear, dry adhesive film. Removes fingerprints and other dirt.

Canister (w/ spray bottle), 1.3 gal. – Part No. 40041
Spray bottle, 17 oz. – Part No. 40040



Brilliance-Clean

For streak- and residue-free cleaning of all surfaces, including stainless steel, steel, aluminum, brass and copper. Brilliance-Clean is not harmful to plastics, wood or coated surfaces. It removes fingerprints, dust, compound residue, minor oil and grease marks and adhesive residue effortlessly. Evaporates quickly without leaving any residue on the surface.

Canister (w/ spray bottle), 1.3 gal. – Part No. 40051
Spray bottle, 17 oz. – Part No. 40050



POLY Protection (oil film)

For cleaning and preserving finished and polished stainless steel and nonferrous metal surfaces. Protects against shadows and finger and water marks for a long time. Spray on and rub off with a micro-fiber cloth. Produces a darker effect on finished surfaces.

Canister (w/ spray bottle), 1.3 gal. – Part No. 40012
Spray bottle, 17 oz. – Part No. 40011

TIPS & TRICKS

A perfect mirror finish on stainless steel

The newly developed grinding and polishing system, featuring special **TZ Pyramid** and **SuperPolish** fabrics from CS Unitec, produces a perfect mirror finish quickly and in just a few steps.

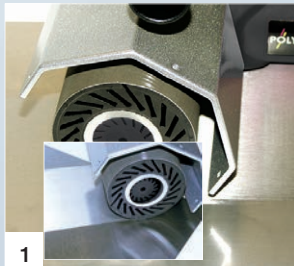

Step 1 - Pre-grinding

Prepare with **TZ Pyramid sleeve** grit A45 (possibly A65) to remove mill skin, scratches and minor unevenness.



Step 2 - Intermediate grinding

Rework with **TZ Pyramid A30** and complete with **TZ Pyramid A16**. Use very little grinding pressure and grind perpendicular and diagonally.



Step 3 - Mirror finish polish

Use the **SuperPolish sleeve** with **white polishing paste**, then with **blue polishing paste**. Use a different sleeve for each paste grit. Polish diagonally. For a high-gloss finish, use the **SuperPolish sleeve** with the **pink high-gloss polishing cream**. Polish in one direction only.

Tip: After each step, remove the compound residue from the workpiece with **POLY Lime and a microfiber cloth.**

The result... a brilliant mirror finish!

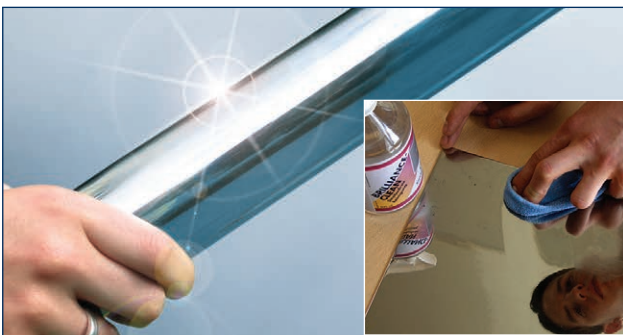

Maintain and protect finished or polished stainless steel surfaces.

Compound and cream residues can be removed using **PTX Lime**. Simply scatter on the lime and wipe it off using a microfiber cloth.

Compound residues, fingerprints, dust, minor oil and grease marks and adhesive residue can be removed effortlessly with **Brilliance-Clean**. Any residue will evaporate immediately.

To protect finished or polished metal surfaces, spray **INOX-Protect** on the surface, rub off with a microfiber cloth, wipe the surface dry and then polish briefly. The surface will be protected by a dry, invisible film for several weeks. Polished finishes will not be darkened by this product.

Abrasives for Pipe Constructions – Open or Closed

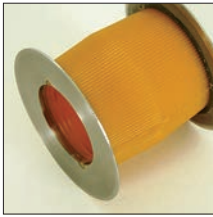

PTX Grinding Belt Roller with stainless steel flanges
For grinding, fleece, SuperPolish and felt belts. The belt roller is made of wear-resistant soft Vulculan with stainless steel discs on the sides. The surface is grooved to ensure that the abrasive belt does not slip.
Diameter: 3.5" x 2.8" Part No. 47006

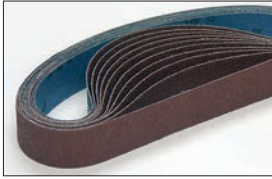

PTX Grinding Belt in high-quality aluminum oxide (closed)
For coarse and initial grinding, rust removal and smoothing round metal pipes. For use with grinding belt rollers. For use on closed pipe constructions, see TIPS & TRICKS below. **Dimensions: 1.2" x 24"**
Grit: 40, 60, 80, 120, 150, 180, 240
See ordering information at right.



PTX TZ Pyramid Belt (closed)
New abrasive fabric with pyramid-shaped grit structure for removing scratches, roller scale and spot welds. TZ Pyramid belts allow high material removal while producing a very fine finish. They are ideal for the initial grinding before polishing to a mirror finish. Because the grit fineness is increased slowly, it is possible to omit several operations. For use with grinding belt rollers. For use on closed pipe constructions, see TIPS & TRICKS below.
Dimensions: 1.2" x 24", Grit: A65, A45, A30, A16, A06
See ordering information at right.



PTX Fleece Nonwoven Belt (open)
Buttonhole fastening system for fine grinding and pre-polishing on open and closed pipe constructions and handrails. The fleece belt can be opened and closed as often as necessary. For use with grinding belt rollers. International patent and design protected.
Dimensions: 1.2" x 26", Grit: coarse, medium, fine, superfine. See ordering information at right.

With buttonhole – **PATENTED!**

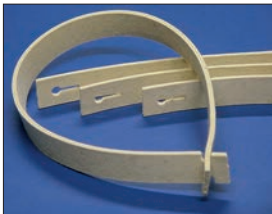

PTX Felt Belt (open)
Made of merino felt with buttonhole fastening system for polishing work on open and closed pipe constructions and handrails. The polishing belt can be opened and closed as often as necessary. For use with grinding belt rollers and our polishing compounds and creams. Use a separate felt belt for each compound and cream grit. Do not use compounds with different grits on felt. International patent and design protected.
Dimensions: 1.2" x 26" Part No. 49004



PTX SuperPolish Belt (closed)
For a perfect mirror finish on pipe constructions and handrails. SuperPolish is a new, special micro fleece that produces a perfect, brilliant mirror finish on stainless steel and nonferrous metals. Smears and shadows are eliminated when used with our polishing compounds (white and blue) and pink cream. SuperPolish is absorbent and saves lots of work time. For use with grinding belt rollers.
Dimensions: 1.2" x 26" (not available with buttonhole fastening system) Part No. 49004N

PTX Grinding Belts (Aluminum Oxide)

Part No.	Grit	Size (width x length)	Quantity
49040	40 grit	1.2" x 24"	10 per pack
49060	60 grit	1.2" x 24"	10 per pack
49080	80 grit	1.2" x 24"	10 per pack
49120	120 grit	1.2" x 24"	10 per pack
49150	150 grit	1.2" x 24"	10 per pack
49180	180 grit	1.2" x 24"	10 per pack
49240	240 grit	1.2" x 24"	10 per pack

PTX TZ Pyramid Belts

Part No.	Grit	Size (width x length)	Quantity
49365	A65/320 grit	1.2" x 24"	10 per pack
49345	A45/400 grit	1.2" x 24"	10 per pack
49330	A30/600 grit	1.2" x 24"	10 per pack
49316	A16/1200 grit	1.2" x 24"	10 per pack
49306	A06/2000 grit	1.2" x 24"	10 per pack

PTX Fleece Nonwoven Belts (open)*

Part No.	Grit	Size (width x length)
49001	coarse (brown)	1.2" x 26"
49002	medium (red)	1.2" x 26"
49003	fine (blue)	1.2" x 26"
49007	superfine (grey)	1.2" x 26"

* Feature buttonhole fastening system



PTX Special Adhesive Tape
With glass fabric insert for joining grinding belts. Strong, heat-resistant adhesive force. For joining PTX grinding and TZ Pyramid belts for use on closed pipe constructions.

Affix the adhesive tape over the entire length of the grinding belt, overlapping approximately 370°.
Dimensions: 1" x 165' Part No. 49000



INOX Miter Tape
Protect adjacent finishes when grinding. Self-adhering 304 Stainless tape for use when creating distinct edges on finishes. Excellent for creating mitered corners. Quick application and

residue-free removal. Minimal thickness for accurate grinding lines. Easily cut with scissors.
Dimensions: One roll measures 6" x 8.2 ft. Part No. 40070

TIPS & TRICKS

Grinding and polishing closed pipe constructions

Fleece and felt belts with the patented buttonhole fastening system are ideal for working on closed pipe constructions and handrails. The grinding belt can be placed over the pipe and closed or opened again in a twist using the buttonhole system. Changing a belt is quick and easy. The belt can be opened and closed as often as required.

Closed belts such as the high-quality aluminum oxide belt or the TZ Pyramid belt must be cut open to work on closed pipe constructions. Place the belt over the pipe and join using our special adhesive tape (P/N 49000) over the entire length (approx. 370°).



MULTI-MAX

Stationary multipurpose grinder for all workshop grinding, blending and finishing jobs.

Uses all PTX abrasive wheels and discs with 5/8"-11 UNC threads or 7/8" arbor.

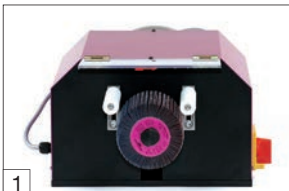

1 Shaft mounting for all abrasives from the PTX ECO SMART system. (See page 7-9)

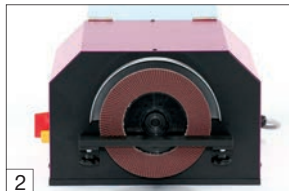

2 5/8" -11 UNC spindle thread for grinding discs or a 7/8" arbor.



3 Uses the FIX HOOK AND LOOP SYSTEM (See pages 23-25). For replacement flap discs, see page 13.



4 Compatible with the new flexible shaft attachment. (See page 13)

Extensive selection of accessories
(See pages 7-9 & 23-25)



3 Uses all PTX abrasive wheels and discs

MULTI-MAX
220 - 240V, 3-phase
Part No. 30402

MULTI-MAX

A versatile bench grinder

- Two shaft mountings. Uses grinding discs with 5/8"-11 UNC or 7/8" mounting and abrasive grinding wheels for longitudinal surface finishers.
- Fast deburring, trimming, grinding, brushing and more.
- Uses Poly-PTX grinding wheels for longitudinal grinding, satin finishing, etc. (See page 7-9)
- Uses FIX HOOK & LOOP system for plain grinding, fine grinding and more. (See pages 23-25)
- Powerful 3-phase, 750 watt AC motor, 220 volt.
- Transparent, hinged grinding guard.
- Roller support for more accurate work.
- Adjustable support rail with safety hood for grinding discs up to 7".
- Drive motor can be used with the flexible shaft for grinding in narrow and awkward spots. (See right)
- For a safe upright working position, use with the MULTI-MAX machine stand. (P/N 30420)



MULTI-MAX Specifications

Order Number: 30402

Power	220 - 240V, 3-phase
Speed	2,800 RPM
Abrasive Diameters	4" to 7"
Disc Mounting	5/8"-11 UNC or 7/8" arbor
Wheel Mounting	Hollow core or Keyway
Weight	5.2 lbs.
Standard Equipment	Multi-Max Tool, 220V PTX Flap Wheel, 80 grit (2) PTX Interleaf, 180 grit (1) Mini polishing pastes, white (P/N 40013) and blue (P/N 40014) Spacer ring set (1) Flat flap disc, 80 grit (1 P/N 36080) FIX backing pad (1 P/N 80115UF) FIX Zirconium discs, 40, 60, 80, 120 grit (1 ea.) FIX TZ Pyramid discs, 400, 600, 1200 grit (1 ea.) FIX SuperPolish disc (1 P/N 80715N)
Replacement Discs	Flat flap disc, 60 grit (1 P/N 36060) Flat flap disc, 80 grit (1 P/N 36080) Flat flap disc, 120 grit (1 P/N 36120)

Flexible Shaft

for use with VARILEX[®], Angle Grinders and MULTI-MAX



The new flexible drive shaft with a sturdy core and 5/8"-11 thread means that the MULTI-MAX can now be upgraded to a powerful professional drive motor. Ideal for narrow and awkward spots. Accepts 1/8" or 1/4" shaft abrasives and with an adapter for polishing rings up to 6" diameter. The Flexible Shaft features an ergonomic handgrip with vibration reduction.

5/8"-11 UNC connecting thread can also be used with the VARILEX[®] WSF 1800 or Angle Grinders!

See page 14-15 for details about the VARILEX[®] WSF 1800.



Flexible Shaft Ordering Information

Item	Part No.
Flexible shaft with 5/16" steel wire and 5/8" thread	10015
Separate 1/8" collet for flexible shaft	10011A
Separate 1/4" collet for flexible shaft	10011B
Machine holder (powder-coated steel) incl. clamping screw for VARILEX [®] WSF 1800	10008

VARILEX® WSF 1800 Professional

The most powerful speed-controlled angle surface finishing and blending tool in its class.

Variable speed from 2000 to 7600 RPM, 15 Amp (1710 W) power, disc change in seconds without tools. For disc diameters of 4", 4-1/2", 5", 6" and 7".



VARILEX® is designed to efficiently maximize the capabilities of flap, grinding and cutting discs and the Hook & Loop system.

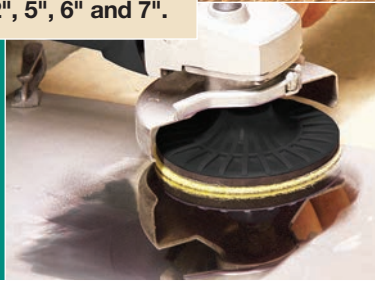

1 Simple, fast disc changing - with no tools - using the **5/8"-11 EASY-LOCK SPEED NUT**. P/N 65008-1



2 New ergonomic design with vibration-damping handle for comfortable, fatigue-free working.



3 Adjustable cover guard.

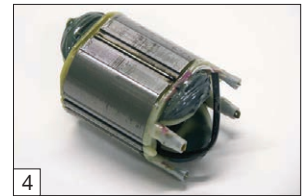

4 Dust-tight field coil with special coating.

Very powerful and infinitely adjustable



VARILEX® WSF 1800 Part No. 65000A

Safety Notice: Always use the protective wheel guard and follow all applicable safety instructions and regulations.



FLEXIBLE SHAFT - The new flexible drive shaft can now upgrade the VARILEX® WSF 1800 to a powerful professional drive motor for all applications. See page 13 for details.



5 Service cover allows the carbon brushes to be changed quickly.



6 Easy speed control during operation.



7 Ergonomically positioned locking ON/OFF switch.



8 QUICK-LOCK cable for fast, easy replacement if cable is damaged. 13 ft., included.

The most powerful single-handed multi-function machine available – more than just an angle grinder!

The VARILEX® boasts a powerful 15 Amp, 1710 W motor that has been designed and developed for heavy industrial use. The speed is infinitely adjustable between 2000 and 7600 RPM. A tachogenerator keeps the speed constant, even when the grinder is operating at full load.

Sensitive variable-speed control makes the VARILEX® ideal for use with both flap discs and polishing discs, as well as grinding and cutting wheels, for applications ranging from grinding to blending, pre-polishing and polishing. The variable-speed control:

- Doubles the service life of the disc being used
- Prevents glazing of the disc and heat deformation on the workpiece
- Drastically reduces the noise level

The VARILEX® differs from a conventional angle grinder in its motor design to allow for exceptional performance at low RPM – without motor overheating or burnout. This machine also offers the ability to change discs in seconds, without tools, using the patented EASY-LOCK clamping nut and spindle lock. It also offers:

- Optimal speed setting for a range of grinding and polishing tools, yielding perfect results every time
- A balanced handle that ensures fatigue-free grinding

The VARILEX® is not designed for continuous use at low speed for polishing paint in the automotive trade.



VARILEX® WSF 1800 Specifications

Order Number: 65000A

Power	15 Amp (1710 Watts) 110 Volt / 60 Hz (Also available: 230 Volt / 50 Hz)	
Speed Control Dial	Infinitely adjustable from 2000 to 7600 RPM	
Diameters	4" to 7"	
Spindle Thread	5/8"-11 UNC	
Arbor Size	7/8"	
Weight	6.2 lbs.	

Use with various discs and safety guards

Available with optional 7" safety guard for use with various-size grinding discs from 4" to 7" diameter (typical disc diameters are 4", 4-1/2", 5", 6" and 7").

5/8"-11 EASY-LOCK SPEED NUT Clamping System



Using the **EASY-LOCK SPEED NUT**, you can change the abrasive disc on the VARILEX® in a matter of seconds – without tools!

Easy hand tightening eliminates the need for wrenches and expensive 5/8"-11 hubs.

Part No. 65008-1

Kit sets for VARILEX® WSF 1800 Professional Multifunction Tool



VARILEX® WSF 1800 Basic Starter Kit Part No. 80053

VARILEX® Basic Starter Kit includes 1 VARILEX® WSF 1800, 110 V with 5/8"-11 spindle, 1 Wheel guard for discs up to 5", 1 Carrying Case, 1 EASY-LOCK SPEED NUT, 2 PLANTEX® CERAMIC 5" grit 40, 2 PLANTEX® 5" grit 40, 2 PLANTEX® CERAMIC 5" grit 60, 2 PLANTEX® 5" grit 60.



FIX Hook & Loop System Kits

See page 23 for two versatile FIX Hook & Loop System kits.



TIPS & TRICKS



Polish stainless steel to a mirror finish with the VARILEX® WSF 1800 Professional

(1) Initial grinding (remove scratches and roller scale, level welds) with TZ Pyramid disc A45 (grit 400) or A65 (grit 320). Finish with TZ Pyramid disc A30 (grit 600) and A16 (grit 1200). (→ page 24)

(2) Main polish with SuperPolish disc and white polishing compound, then with blue polishing compound. Important: Use a separate disc for each compound grit.

(3) Mirror finish with SuperPolish disc and pink polishing cream. (→ page 10)

FLAP DISCS

Longer, faster and better grinding.



Unbeatable technology and performance

The first flap discs for high-speed angle grinders were developed at the end of the 1970s. More than 30 years of experience and unbeatable technology go into the manufacture of every CS Unitec flap disc. In terms of material removal capacity, service life and grinding quality, the flap discs that bear the brand TIGER SHARK-PLANTEX® – plus the newest development, PLANTEX®, made of hemp fiber high-tech compound – are among the best in the world.

Top of the class in material removal, service life and quality

The performance and service life of a flap disc are not only dependent on the abrasive fabric used, but above all on the correct combination of flexible backing material; grit mixtures on the flaps; the angle at which the flap is held against the material; hard pressing; gluing system; and more. These considerations are part of what sets CS Unitec apart from the rest – not all flap discs are the same!

Good for the environment and better for your health

Great care is taken to select raw materials that are environmentally sound and user friendly. Commonly used materials such as fiberglass, mineral fibers and epoxy resins are avoided in favor of sustainable raw materials such as hemp for the discs' backing plates. A patented, revolutionary flexible adhesive mounting system for the abrasive fabric flaps further contributes to the safety, performance, service life and user friendliness of CS Unitec flap discs. Our discs also considerably reduce vibration and noise while grinding.

Unique patented production process

Completely new production technologies have been developed to manufacture our high-quality flap discs. The adhesion of the flaps to the backing disc is achieved using a patented, revolutionary adhesive system. In contrast to many rival products, the flaps of CS Unitec's discs are pressed on to the backing disc over their full area – throughout the entire hardening process – to produce a solid, compact and vibration-stable abrasive. This also gives added support to the grits and holds them firmly in their mounting, considerably extending the service life of the grinding discs.

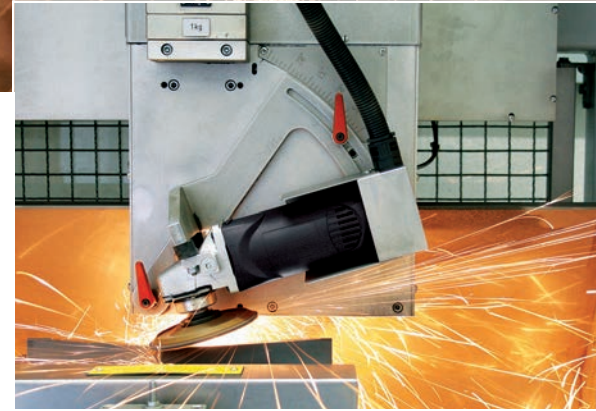

Standard and endurance tests ensure quality and play an essential role in progressive new developments.

Speed test

Grinding discs are tested on a centrifugal test machine to ensure that they can withstand the sort of speeds that are required for grinding work. The test system can test discs at speeds of up to 30,000 RPM.

Endurance grinding test

Endurance tests are conducted to measure the material removal and service life of flap discs. New fabrics are tested to ensure their suitability and their grinding properties on various materials.

Compliant with American and German standards set by ANSI B7.1 and DIN 13743.

▼ TIPS & TRICKS



CS Unitec Flap Disc



Standard Flap Disc

A clear difference

These pictures show the clear difference between a CS Unitec flap disc with hard-pressed flaps (top) and a standard flap disc with fiberglass backing and unpressed flaps (bottom). The poorly pressed disc tends to "chatter" during the grinding process, generating vibrations and resulting in the grit pulling away from the mounting prematurely. This results in irregular grinding, poor grinding capacity, short service life and potential flap tearing.

Check the speed

The right speed increases the service life of flap discs by up to 100% – a major factor in ensuring a low-cost workflow. Operating flap discs between 5000 and 8000 RPM sets the table for optimal grinding capacity and service life. Powerful, speed-controlled angle grinders such as the VARILEX® WSF 1800 Professional (see page 14) are ideal for working with flap discs.

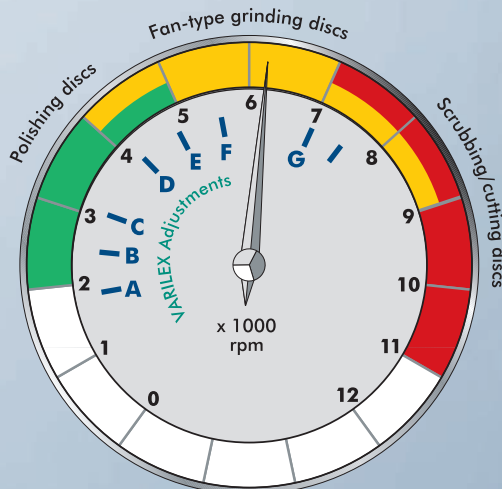

Recommended speeds for maximum flap disc service life and economy:

4" diameter:	9000 – 11,000 RPM
4-1/2" diameter:	7000 – 9000 RPM
5" diameter:	6000 – 8000 RPM
6" diameter:	5000 – 7000 RPM
7" diameter:	4000 – 6000 RPM

Grinding & Polishing Discs



PLANTEX®

Flap discs for grinding steel and stainless steel, with hemp/polypropylene backing.

See page 18-20



PLANTEX® COOL TOP

Provides additional cooling to improve grinding performance for stainless steel.

See page 20



PLANTEX® CERAMIC

Provides increased performance and additional cooling to improve service life on all metals. **See page 21**



PLANTEX® TIGER SHARK®

Specially designed for blending aluminum.

See page 22



FIX HOOK & LOOP SYSTEM

Highly flexible backing disc for outstanding finish quality.

See page 23-25



POLY-MAGIC-WHEEL

Ideal for dry polishing stainless steel.

See page 26



MAGNUM® FLEECE TOP

For surface conditioning, fine finishing and polishing.

See page 27



MAGNUM® CLEAN

For pore-deep cleaning of metals.

See page 27



REDUCED SPARKING & CUT-OFF DISCS

EB diamond wheels reduce sparking.

See page 28-29

PLANTEX®

High-tech Compound

A quantum leap in flap disc technology.

Provides:

- ✓ Higher Productivity
- ✓ Lower Cost
- ✓ Increased Safety

Steel/Stainless Steel/Aluminum



PLANTEX® offers important advances in grinding performance, service life, protection for the environment and personal safety.

The development of the new PLANTEX® high-tech compound has resulted in the production of the first flap discs in the world with a backing plate made of natural hemp, with polypropylene used to bind it. In addition to excellent material abrasion and a long service life, the discs offer maximum operator safety, protection of natural resources and environmental friendliness.

This new composite material (hemp and polypropylene) minimizes pollution from production to waste disposal. Even the polypropylene binding material combusts to approximately 1% carbon when disposed of by thermal methods, producing almost zero residue. Polypropylene is physiologically safe and is used in automotive engineering (interior) and medical technology for common items such as syringes, cannulae and infusion bottles. As a result of its fiber structure, the hemp fiber offers excellent tearing strength values. The superior strength values of this high-tech compound are achieved through a patented new treatment ("impact method") for hemp fibers.

Hemp fiber high-tech compound is an almost ideal base material for flap disc backing plates – it is flexible, heat-absorbent (for low grinding temperatures), very easy to trim, safe to use and easy to dispose of. The cavities of the hemp fiber structure, in conjunction with polypropylene, have a highly insulating, damping and noise-reducing effect, thus enhancing the safety features of the discs.



Made in Germany

PLANTEX®

Hightech-Compound

PATENTED!



Safer working conditions

- No fiberglass, no mineral fibers, no epoxy resin
- Easy to trim, safe to use, easy to dispose of

Earth friendly

- Minimizes pollution, from production to disposal
- Hemp plant counteracts greenhouse effect

Competitively priced

- Lower cost of production
- Superior service life; 100% utilization

The high-tech compound material used for the PLANTEX® flap disc is perfectly safe. The backing plate is trimmed automatically during the grinding process or can be trimmed manually using cutting tools. The CO₂ and energy balance are also impressive. During its growth, 1 ton of hemp converts approximately 2 tons of carbon dioxide into oxygen by means of photosynthesis. Hemp therefore plays a beneficial role in counteracting the greenhouse effect.



Trimming with cutting tools produces soft, harmless chips that can be disposed of as domestic waste (smell is similar to wood chips). Thermal disposal incinerates without residue, apart from 1% carbon.

Grinding down to the last fraction of an inch

The backing plate used on PLANTEX® flap discs reduces in diameter automatically during grinding. It can also be trimmed with cutting tools, a process that is simple and straightforward. The PLANTEX® flap disc can be used down to the last flap of the abrading fabric – and saves you money in the process!

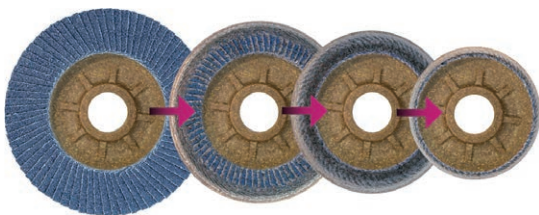

100% Service Life!

Use down to the last abrasive flap by automatic trimming during grinding or trimming using cutting tools on a sharp steel edge.

Ordering information for general-use PLANTEX® flap discs, as well as the full line of PLANTEX® products, begins on the next page.

PLANTEX® – features to convince everybody!



- Superior material abrasion and service life due to the discs' springy elasticity and 100% pure zirconium.
- Self-trimming and very easy to cut – the backing plate reduces in size automatically during the grinding process.
- Adjusts better to the surface of the workpiece during grinding.
- Absorbs vibration and noise due to its high fiber content.
- Heat-absorbent high-tech compound (with hollow fiber insulation) reduces the temperature during grinding.
- High strength, yet lightweight.
- High shape stability while maintaining elasticity.
- High-tech compound is resistant to most chemicals.
- Made of a sustainable raw material – protects valuable natural resources.
- The backing plate can be disposed of safely and easily (polypropylene binding combusts to approx. 1% carbon).
- Hemp provides good energy and CO₂ balance.
- Outstanding value: PLANTEX® costs no more than a medium-quality conventional flap disc.

The clever ones give way!



The fiber substrate of the PLANTEX® high-tech compound gives it absorbent, spring-like properties that enhance grinding performance. This flexibility provides a greater contact surface area with the workpiece (more grit is used) that results in more material being abraded. The material removal capacity is therefore higher. The larger contact surface area also dissipates more heat, making the grinding work cooler – the workpiece does not suffer smearing and the abrasive fabric does not burn.

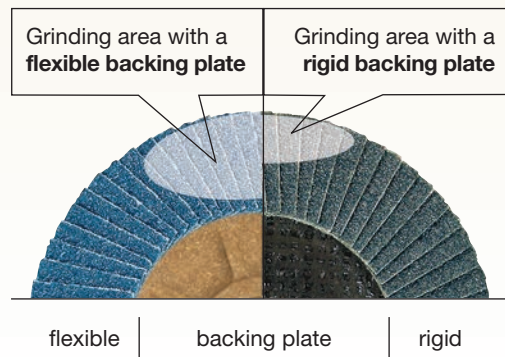

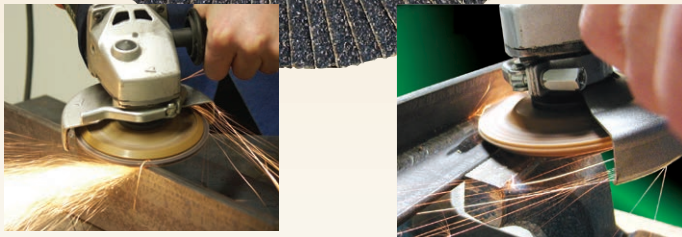
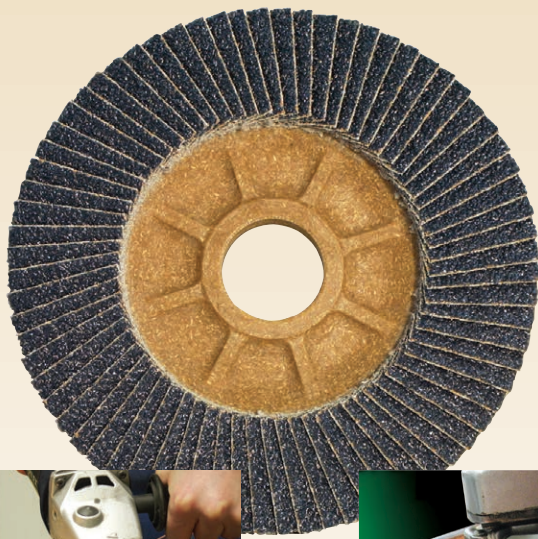

PLANTEX® Specifications

Dimensions	Diameter: 4", 4-1/2", 5", 7"
Max. speed	13,200 RPM for 4-1/2" diameter
Ideal speed	5000 to 8000 RPM
Complies with	ANSI B7.1, 260 ft./sec. DIN EN 13743
Grits	40, 60, 80, 120
Arbor size	5/8" or 7/8"

PLANTEX®

Flexible flap disc for general use.

The PLANTEX® high-tech compound is becoming the standard flap disc for many companies. The backing plate is made of hemp fiber and can be trimmed completely. High grinding performance is achieved with the extreme flexibility of the backing plate and the 100% RZ-Zirconium abrasive fabric.

PLANTEX® Ordering Information

Part No.	Size (dia. x arbor)	Grit	Maximum Speed	Quantity
93514	4" x 5/8"	40	15,000 RPM	10 pack
93516	4" x 5/8"	60	15,000 RPM	10 pack
93518	4" x 5/8"	80	15,000 RPM	10 pack
93524	4-1/2" x 7/8"	40	13,200 RPM	10 pack
93526	4-1/2" x 7/8"	60	13,200 RPM	10 pack
93528	4-1/2" x 7/8"	80	13,200 RPM	10 pack
93529	4-1/2" x 7/8"	120	13,200 RPM	10 pack
93534	5" x 7/8"	40	12,200 RPM	10 pack
93536	5" x 7/8"	60	12,200 RPM	10 pack
93538	5" x 7/8"	80	12,200 RPM	10 pack
93539	5" x 7/8"	120	12,200 RPM	10 pack
93544	7" x 7/8"	40	8600 RPM	10 pack
93546	7" x 7/8"	60	8600 RPM	10 pack
93548	7" x 7/8"	80	8600 RPM	10 pack
93549	7" x 7/8"	120	8600 RPM	10 pack



PLANTEX® COOL TOP®

Flap disc with cool performance for grinding stainless steel.

The PLANTEX® COOL TOP® high-tech compound has been specifically developed for grinding stainless steel.

A new abrasive fabric with additional top-size coating improves grinding performance and service life and also provides additional cooling.

PLANTEX® COOL TOP® Ordering Information

Part No.	Size (dia. x arbor)	Grit	Maximum Speed	Quantity
93614	4" x 5/8"	40	13,200 RPM	10 pack
93616	4" x 5/8"	60	13,200 RPM	10 pack
93624	4-1/2" x 7/8"	40	13,200 RPM	10 pack
93634	5" x 7/8"	40	12,200 RPM	10 pack
93636	5" x 7/8"	60	12,200 RPM	10 pack
93644	7" x 7/8"	40	12,200 RPM	10 pack



PLANTEX® COOL TOP® Specifications

Dimensions	Diameter: 4", 4-1/2", 5", 7"
Max. speed	13,200 RPM for 4-1/2" diameter
Ideal speed	5000 to 8000 RPM
Complies with	ANSI B7.1, 260 ft./sec. DIN EN 13743
Grits	40, 60 (for finer grits, use PLANTEX 80 & 120)
Arbor size	5/8" or 7/8"

PLANTEX® CERAMIC

Ceramic high-performance flap disc with exceptional grinding performance for universal use on stainless steel and hard-to-grind metals. Save labor and time – one flap disc for all metals.

Advanced high-performance ceramic grain improves grinding performance for maximum removal, saves time, extends service life and provides additional cooling.

The PLANTEX® high-tech compound is becoming the standard flap disc for many companies. It is fiberglass free and provides excellent performance and service life. PLANTEX® natural fiber hemp backing plate offers flexibility to reduce vibration and increase performance. The PLANTEX® disc's composition also protects the environment and precious resources.

The PLANTEX® CERAMIC high-tech compound has been specifically developed for grinding all metals including stainless steel, steel, aluminum, titanium, bronze and special alloys. Self-trimming backing pad allows for 100% use of abrasive.

PLANTEX® CERAMIC Specifications

Dimensions	Diameter: 4-1/2" and 5"
Max. speed	13,200 RPM for 4-1/2" diameter
Ideal speed	5000 to 8000 RPM
Complies with	ANSI B7.1, 260 ft./sec. DIN EN 13743
Grits	40, 60, 80
Arbor size	7/8"

PLANTEX® CERAMIC Ordering Information

Part No.	Size (dia. x arbor)	Grit	Maximum Speed	Quantity
93550	4-1/2" x 7/8"	40	13,200 RPM	10 pack
93551	4-1/2" x 7/8"	60	13,200 RPM	10 pack
93552	4-1/2" x 7/8"	80	13,200 RPM	10 pack
93555	5" x 7/8"	40	12,200 RPM	10 pack
93556	5" x 7/8"	60	12,200 RPM	10 pack
93557	5" x 7/8"	80	12,200 RPM	10 pack

NEW!

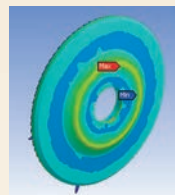

Strength & safety with FEM

The backing plate for the PLANTEX® high-tech compound is calculated using the finite element method (FEM). That ensures that it provides the optimal strength and safety properties, while minimizing material use. Like all flap discs from CS Unitec, PLANTEX® flap discs are approved for 260 ft./sec. to DIN EN 13743 and have been approved by the MPA (Material Testing Institute) in Hanover and by the BGIA (Professional Association Institute for Industrial Safety). PLANTEX® additionally complies with ANSI standard B7.1.



Easy Disc Changeover – No Wrenches or Hubs Required!

Grinding discs can be changed in seconds, without tools, using the 5/8"-11 EASY-LOCK SPEED NUT. It is easily tightened by hand and eliminates the need for wrenches or expensive hubs.

Part No. 65008-1





Aluminum



Unique flap discs with a PLANTEX® flexible backing disc.



PLANTEX® TIGER SHARK® & KANGAROO ALU-FIX® OIL

The new dimension for grinding aluminum.

PLANTEX® TIGER SHARK® elastic discs are unbeatable for the difficult grinding of aluminum. High material removal, reduced grinding temperature and no glazing with aluminum particles make the TIGER SHARK® the first choice for these applications. This flap disc, with its ceramic/corundum cotton abrasive fabric, also offers high grinding capacity and low tool costs for steel and nonferrous metals. The backing plate is flexible PLANTEX® earth-friendly compound and adjusts well to the shape of the workpiece. TIGER SHARK® is ideal for grinding curved surfaces and shapes, and it is often used in car body shops, car workshops and for tool making.

The excellent features of the TIGER SHARK® can be enhanced even further with the newly developed Kangaroo ALU-FIX® OIL. A quick spray on the workpiece will solve many of the problems you may have encountered while grinding aluminum in the past. Loading no longer occurs, the material removal rate is up to 300% higher, the finish is visibly better – and the flap disc will last up to three times longer.

PLANTEX® TIGER SHARK® Specifications

Dimensions	Diameter: 4", 4-1/2", 5", 7"
Max. speed	13,200 RPM for 4-1/2" diameter
Ideal speed	5000 to 8000 RPM
Complies with	ANSI B7.1, 240 ft./sec. DIN EN 13743
Grits	40, 60, 80, 120
Arbor size	5/8" or 7/8"

PLANTEX® TIGER SHARK® Ordering Information

Part No.	Size (dia. x arbor)	Grit	Maximum Speed	Quantity
93814	4" x 5/8"	40	15,000 RPM	10 pack
93816	4" x 5/8"	60	15,000 RPM	10 pack
93818	4" x 5/8"	80	15,000 RPM	10 pack
93819	4" x 5/8"	120	15,000 RPM	10 pack
93824	4-1/2" x 7/8"	40	13,200 RPM	10 pack
93826	4-1/2" x 7/8"	60	13,200 RPM	10 pack
93828	4-1/2" x 7/8"	80	13,200 RPM	10 pack
93829	4-1/2" x 7/8"	120	13,200 RPM	10 pack
93834	5" x 7/8"	40	12,200 RPM	10 pack
93836	5" x 7/8"	60	12,200 RPM	10 pack
93838	5" x 7/8"	80	12,200 RPM	10 pack
93839	5" x 7/8"	120	12,200 RPM	10 pack
93844	7" x 7/8"	40	8600 RPM	10 pack
93846	7" x 7/8"	60	8600 RPM	10 pack
93848	7" x 7/8"	80	8600 RPM	10 pack
93849	7" x 7/8"	120	8600 RPM	10 pack

Kangaroo ALU-FIX® OIL

Spray on aluminum workpiece to improve the removal rate and increase abrasive life. Available in a 1 pint spray bottle or a 1.3 gal. canister with a spray bottle.

- 1-pint spray bottle – **Part No. 40010**
- 1.3 gal. canister and spray bottle – **Part No. 40010K**



FIX HOOK & LOOP SYSTEM

Highly elastic backing disc for previously impossible finish quality. Ideal for surface conditioning and polishing up to a mirror finish.

The FIX Hook & Loop system takes advantage of a flexible backing pad and allows a disc to be changed in seconds without tools.

The FIX Hook & Loop system is a good fit wherever disc flexibility and frequent changeover are important. It will save time in industrial metalworking applications such as car body shops and repair shops.

The system requires a speed-controlled angle grinder, such as the VARILEX® WSF 1800 Professional. A wide range of abrasives are available for all steps leading from rough grinding up to a mirror finish.

The FIX Hook & Loop's "green" backing disc is made of natural materials. The flexibility of the abrasives allows you to achieve results similar to stationary grinding machines.

PATENTED!

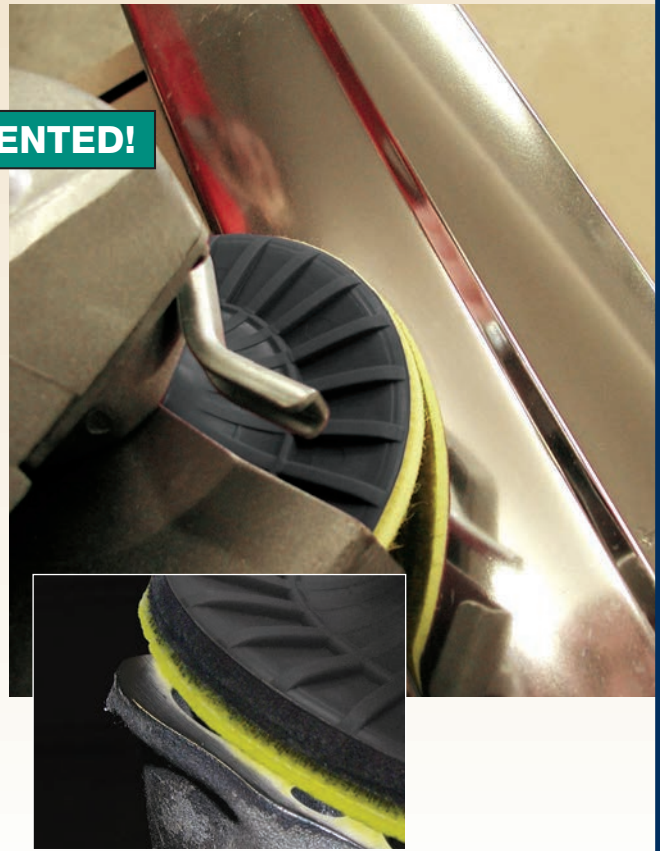

The FIX Hook & Loop system is an essential surface finishing and polishing system for all sheet metal applications.

The FIX family of abrasives must be used with the FIX original backing disc.

FIX Hook & Loop System Kits



FIX Test Kit

This kit contains all the FIX Hook & Loop System components to go from rough grinding up to a mirror finish. **Part No. 80051U**

- 1 Carrying case
- 1 FIX backing pad
- 8 FIX Zirconium discs 4-1/2"
(2 each - 40, 60, 80, 120 grit)
- 10 FIX TZ Pyramid discs 4-1/2"
(2 each - 320, 400, 600, 1200, 2000 grit)
- 8 FIX Surface Conditioning discs 4-1/2"
(2 each - coarse, medium, fine, superfine)
- 6 FIX SuperPolish discs 4-1/2"
- 2 Mini-polishing pastes, white and blue
- 1 PTX polishing cream pink
- 1 PTX Lime in a can
- 2 PTX microfiber cloths
- 1 Sample size PTX Poly Protection
- 1 Sample size PTX Brilliance Clean



FIX Starter Kit

This kit includes a range of FIX Hook & Loop components, as well as a VARILEX® WSF 1800 Angle Grinder. **Part No. 80050U**

- 1 VARILEX® WSF 1800, 110V, 5/8" spindle
- 1 Carrying case
- 1 FIX backing pad - 4-7/16"
- 1 Wheel guard for discs up to 5"
- 3 FIX fleece discs 4-1/2" (1 each - coarse, medium, fine)
- 1 EASY-LOCK SPEED NUT
- 2 FIX FLEECE TOP 4-1/2" (1 each - grit 80, 180)
- 2 FIX flap discs 4-1/2" (1 each - grit 40, 60)
- 2 FIX SuperPolish discs 4-1/2"
- 1 FIX clean 4-1/2"
- 1 Lime scatter can
- 4 FIX Zirconium discs 4-1/2" (1 each - grit 40 - 120)
- 2 Mini-polishing pastes, white and blue

Abrasives for the FIX Hook & Loop System

The FIX family of abrasives must be used with the FIX original backing disc.



Special FIX Backing Pad with Centering Pin, without Foam
For use with the FIX Zirconium disc, FIX TZ Pyramid disc and FIX SuperPolish disc. The backing disc is made of special elastic material with a centering pin for perfect alignment.

Diameter: 4-1/2" with 5/8"-11 thread – **Part No. 80115U**
Diameter: 6" with 5/8"-11 thread – **Part No. 80150U**



Special FIX Backing Disc with PUR Foam Absorption Coating and Centering Pin
For use with the FIX Zirconium disc, FIX TZ Pyramid disc and FIX SuperPolish disc. The backing disc is made of flexible PUR with a special 1/4" absorption coating with a centering pin for perfect alignment.

Diameter: 4-1/2" with 5/8"-11 thread – **Part No. 80115UF**
Diameter: 6" with 5/8"-11 thread – **Part No. 80150UF**



FIX Zirconium Disc

Abrasive disc with Hook & Loop fastening and an outstanding grinding capacity. Ideal for body shops and car workshops.

Diameter: 4-1/2" and 6"; Grits: 40, 60, 80, 120

FIX Zirconium Disc Ordering Information

Part No.	Diameter	Grit	Quantity
80904	4-1/2"	40	50 pack
80906	4-1/2"	60	50 pack
80908	4-1/2"	80	50 pack
80909	4-1/2"	120	50 pack
80914	6"	40	50 pack
80916	6"	60	50 pack
80918	6"	80	50 pack
80919	6"	120	50 pack

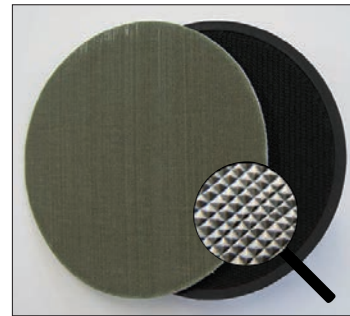

FIX TZ Pyramid Disc

New abrasive fabric with pyramid-shaped grit structure for high material removal while producing a very fine finish. FIX TZ Pyramid discs reduce the amount of work required compared to grinding belt sleeves and fleece sleeves. Ideal for pre-polishing for mirror finishes and for removing scratches and spot welds. An additional absorption coating drastically reduces the grinding temperature and protects the Hook & Loop components and the workpiece.

Diameter: 4-1/2" and 6"; Grits: A65, A45, A30, A16, A06 (see grit equivalents below)

FIX TZ Pyramid Disc Ordering Information

Part No.	Diameter	Grit	Quantity
80932	4-1/2"	A65/320	10 pack
80940	4-1/2"	A45/400	10 pack
80960	4-1/2"	A30/600	10 pack
80970	4-1/2"	A16/1200	10 pack
80980	4-1/2"	A06/2000	10 pack
80985	6"	A65/320	10 pack
80986	6"	A45/400	10 pack
80987	6"	A30/600	10 pack
80988	6"	A16/1200	10 pack
80989	6"	A06/2000	10 pack

Grit Equivalents

A100 = Grit 220 A30 = Grit 600
A65 = Grit 320 A16 = Grit 1200
A45 = Grit 400 A06 = Grit 2000

More Abrasives for the FIX Hook & Loop System



FIX Fleece (Nonwoven) Disc
 Versatile disc for fine surface conditioning and pre-polishing.
Diameter: 4-1/2" and 6"
Grits: coarse, medium, fine, superfine



FIX-Klett (Nonwoven) Disc

The new FIX-Klett disc is a superfine soft nylon-fleece material for prepolishing aluminum or other soft, nonferrous materials to a mirror finish.

Diameter: 4-1/2"; Superfine grit, Part No. 80680 (10 pack)
Diameter: 6"; Superfine grit, Part No. 80690 (10 pack)

FIX Fleece (Nonwoven) Disc Ordering Information

Part No.	Diameter	Grit	Quantity
80615	4-1/2"	coarse (brown)	10 pack
80616	4-1/2"	medium (red)	10 pack
80617	4-1/2"	fine (blue)	10 pack
80618	4-1/2"	superfine (grey)	10 pack
80650	6"	coarse (brown)	10 pack
80651	6"	medium (red)	10 pack
80652	6"	fine (blue)	10 pack
80653	6"	superfine (grey)	10 pack

SuperPolish Discs for the FIX Hook & Loop System

When polishing with **FIX SuperPolish Discs**, use a separate SuperPolish disc for each compound and cream. The different compound grits must not be mixed. Remove compound and cream residues from the workpiece after each stage using POLY-PTX® lime and a microfiber cloth.



FIX SuperPolish Disc

SuperPolish is a new, special needle fleece that produces a perfect, brilliant mirror finish on stainless steel and nonferrous metals. Used with our polishing compounds (white and blue) and pink cream to avoid smears and shadows. SuperPolish is absorbent, does not smear and saves time.

Diameter: 4-1/2"; Thickness: 1/4", Part No. 80715N (10 pack)
Diameter: 6"; Thickness: 1/4", Part No. 80750N (10 pack)

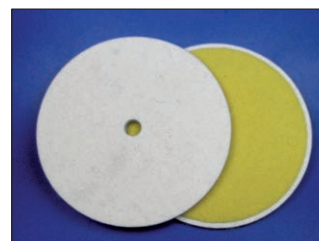

FIX SuperPolish Felt Disc

Special merino wool felt that produces a perfect, brilliant mirror finish on stainless steel and nonferrous metals. Used with our polishing compounds (white and blue) and pink cream to avoid smears and shadows.

Diameter: 4-1/2"; Thickness: 1/4", Part No. 80715 (10 pack)
Diameter: 6"; Thickness: 1/4", Part No. 80750 (10 pack)

↘ TIPS & TRICKS

Perfect mirror finish on stainless steel and nonferrous metals

The new TZ Pyramid and SuperPolish discs for the FIX Hook & Loop system can be used with an angle grinder to create perfectly polished finishes on stainless steel and nonferrous metals.

Pre-grinding to remove scratches and level welds using TZ Pyramid discs with grit A30.

Fine grinding using TZ Pyramid discs with grit A16.

These two stages prepare the surface for polishing. TZ Pyramid is an aggressive abrasive, so there is no need to slowly increase the grit fineness. Use only contact pressure to grind – the weight of the grinder is generally sufficient.

Pre-polish with SuperPolish disc and white polishing compound.

Main polish with SuperPolish disc and blue polishing compound.

Perfect mirror finish with SuperPolish disc and pink cream.

Use a separate SuperPolish disc for each step – the different compound grits must not be mixed. Remove compound and cream residues after each stage using POLY-PTX® lime and a microfiber cloth.



Polishing corner welds with the POLY-MAGIC-WHEEL

Obtaining good polish quality when finishing corner welds is difficult, especially for the fabrication of railings. The POLY-MAGIC-WHEEL was designed to help you more easily produce a truly perfect finish in these applications. This highly compacted fleece disc was designed specifically for grinding and polishing bead and corner welds. The POLY-MAGIC-WHEEL disc can reduce the time required for this work to a minimum, and the result can only be described as a minor miracle.

Carry out the initial grinding and leveling of welds with the red disc, grit A (80 grit).

Then polish to a mirror finish using the POLY-MAGIC gray disc, grit B (900 grit). These discs are very aggressive; they save a lot of working time and the result is sensational. No polishing compounds or creams are required for polishing with the POLY-MAGIC-WHEEL (dry polish).

POLY-MAGIC-WHEEL

Dry polish stainless steel in corners up to a mirror finish!

The POLY-MAGIC-WHEEL is designed for finishing and dry polishing in corners, producing up to a perfect mirror finish in just two steps. These discs are made of highly compressed fleece material and are made in a sophisticated production process using compressed single flaps that are strengthened by being impregnated with foam. This special process allows considerably more abrasive material to be used than on conventionally wound "unitized wheels and discs."

The POLY-MAGIC-WHEEL is ideal for grinding and polishing bead and corner welds. It may only be used frontally.

Ideal for speed-controlled angle grinders.

POLY-MAGIC-WHEEL

Dimensions	6-1/2" dia. x 7/8" arbor
Max. speed	5000 RPM
Ideal speed	3000 to 4000 RPM
Grits	A/80 (red) Initial grinding & leveling welds (P/N 96720, 5 pk.) B/900 (gray) Polishing to a perfect mirror finish (P/N 96721, 5 pk.)

Mirror finish in 2 steps:

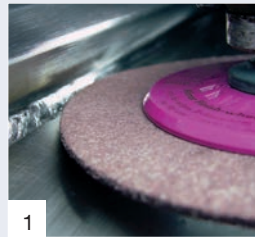

1 POLY-MAGIC-WHEEL A (80 grit)



2 POLY-MAGIC-WHEEL B (900 grit)

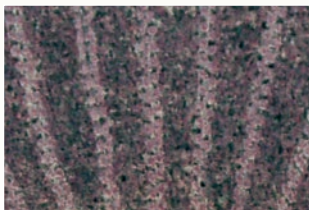

MAGNUM® TOPMIX

Increased material removal, longer service life.

The MAGNUM® TOPMIX was developed to increase material removal during finishing while also improving service life. The 80 combination grit is much more aggressive than our MAGNUM® FLEECE TOP 80 grit (see page 27). Individual flaps with foamed and compressed fleece offer a much higher removal capacity, making it ideal for removing spot welds and deep scratches on stainless steel, steel and nonferrous metals. The coordinated fleece combination additionally ensures that a good finish is achieved. The MAGNUM® TOPMIX also offers excellent service life, making deburring and cleaning of cast parts and welds a breeze.

Ideal for speed-controlled angle grinders.

MAGNUM® TOPMIX

Dimensions	5" dia. x 7/8" arbor
Ideal speed	2000 to 4500 RPM
Max. speed	6000 RPM
Grit	80 (P/N 96705, 5 pk.)

MAGNUM® FLEECE TOP

Made of foamed, compressed-grit, interspersed nonwoven fleece.

The MAGNUM® FLEECE TOP is a versatile fleece disc for surface conditioning, fine finishing and polishing, offering up to eight times the service life of traditional fleece and SC discs. Its range of uses is impressive. The FLEECE TOP is an ideal disc for metalworking that requires fine grinding and pre-polishing to a uniform clean finish, and it is effective at descaling and removing oxidation, scratches, rust, burrs and paint. It replaces a wire brush, abrasive paper and grinding rubbers and is self cleaning, with a special mixture that prevents glazing and loading. The foamed fleece ring is approx. 5/8" thick. This highly compressed quantity of fleece material ensures an extra-long service life.

Ideal for speed-controlled angle grinders.

MAGNUM® FLEECE TOP

Dimensions	4-1/2" dia. x 7/8" arbor
Ideal speed	2000 to 4500 RPM
Max. speed	8000 RPM
Grits	80 (P/N 96710, 5 pk.) 180 (P/N 96711, 5 pk.) 280 (P/N 96712, 5 pk.) 400 (P/N 96713, 5 pk.) 600 (P/N 96714, 5 pk.) 900 (P/N 96715, 5 pk.)

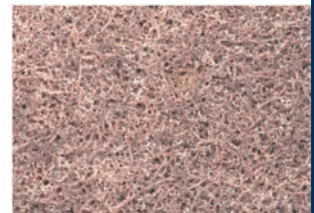
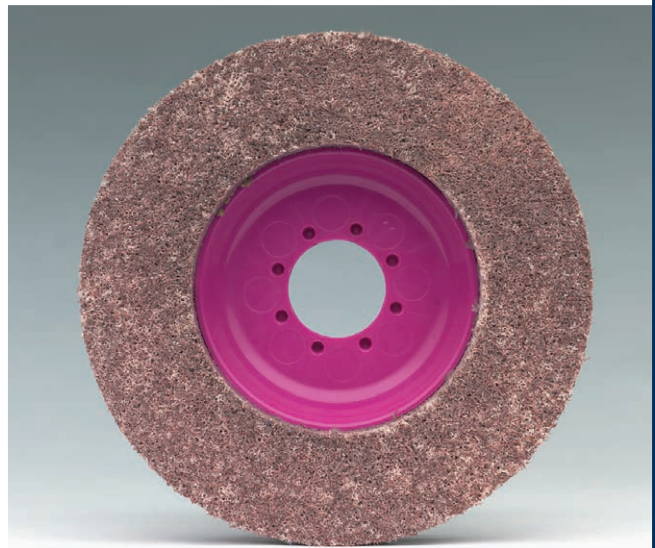

MAGNUM® CLEAN

For pore-deep cleaning of metals (sandblasting effect).

MAGNUM CLEAN® is a flexible cleaning disc for the pore-deep cleaning of metals. This flexible coarse fleece disc is interspersed with silicon carbide grit and cleans without harming the base material. The disc itself is iron free, which means that there is no risk of corrosion. The coarse fleece material will not glaze or load, even if exposed to heavy contamination. MAGNUM CLEAN® is the ideal cleaning disc for pore-deep removal of paint, rust, scale and oil smears, as well as for cleaning and exposing without material removal. It is ideal for use in body shops (cleans thin sheet metal with no material removal) and in the automotive industry, and it is also suitable for underseal, renovating, painting and building work. MAGNUM CLEAN® is particularly good for removing paint and other coatings on wood, stone and metal (including window frames, doors and frames, furniture, house facades, graffiti, railings, fences, supports and machines).

Ideal for speed-controlled angle grinders.

MAGNUM® CLEAN

Dimensions	5" dia. x 7/8" arbor
Ideal speed	2000 to 4500 RPM
Max. speed	5000 RPM
Grit	Medium (P/N 96700, 10 pk.)

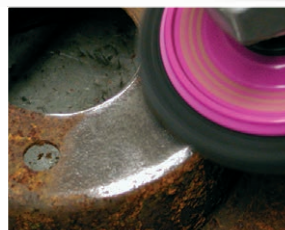



Benefits of reduced sparking:

- Workpiece visibility is improved, allowing more accurate grinding
- Reduced fire hazard from sparks

REDUCED SPARKING GRINDING DISCS

Designed for grinding steel, stainless steel and other materials in nuclear plants, oil and gas industries and applications where spark reduction is an important feature.

Eco Brazing (EB) diamond grinding discs from CS Unitec reduce sparking to 1% of that produced by resinoid wheels, making EB diamond a better choice than resinoid for use in some hazardous environments.

- Diamond grit protrudes higher off the EB diamond disc than traditional diamond wheels, providing greater durability, longer service life and ease in cutting
- High-tensile steel backing disc reduces plate thickness for a lightweight wheel that allows for high-rotation grinding
- High yield strength makes the steel backing disc flexible, helping to ensure that operators do not grind the material by over-removal
- Reduced sparking increases the visibility of the workpiece
- The EB diamond wheel wears approximately 1% as much as a resinoid wheel, therefore significantly reducing the amount of abrasive dust emitted
- Ideal for grinding steel and stainless steel, as well as natural stone, granite, marble, fiberglass and other materials



EB DIAMOND DISC Specifications

Dimensions	Diameter: 4", 7"
Max. speed	13,000 RPM (4") or 8500 RPM (7")
Ideal speed	6000 RPM (4") or 3300 RPM (7")
Grits	30, 40, 50, 60, 80
Arbor size	7/8"

EB DIAMOND DISC Ordering Information

Order No.	Size (dia. x arbor)	Grit	Max. Speed	Quantity
EB4007830	4" x 7/8"	30	13,000 RPM	1 disc
EB4007840	4" x 7/8"	40	13,000 RPM	1 disc
EB4007850	4" x 7/8"	50	13,000 RPM	1 disc
EB4007860	4" x 7/8"	60	13,000 RPM	1 disc
EB4007880	4" x 7/8"	80	13,000 RPM	1 disc
EB7007830	7" x 7/8"	30	8500 RPM	1 disc
EB7007840	7" x 7/8"	40	8500 RPM	1 disc
EB7007850	7" x 7/8"	50	8500 RPM	1 disc
EB7007860	7" x 7/8"	60	8500 RPM	1 disc
EB7007880	7" x 7/8"	80	8500 RPM	1 disc

Though EB diamond discs have been shown to reduce sparking, we make no claim that sparking will be eliminated. Follow all appropriate safety regulations (ATEX, OSHA, ANSI) for all grinding applications, including those for working in hazardous environments.



EB diamond grinding discs reduce sparking up to 1/100 of that produced by resinoid grinding wheels (inset left).



REDUCED SPARKING DIAMOND GRINDING AND CUTTING DISCS

Caution: User must follow all appropriate safety regulations when choosing a tool for their particular working environment.

Follow all appropriate safety regulations (ATEX, OSHA, ANSI, etc.) for all grinding applications, including those for working in hazardous environments. Follow all appropriate OSHA and international safety regulations for grinding metal, fiberglass, hard plastics and more.

- Last 100x longer than ordinary resin bonded wheels
- Reduce sparks, dust and material waste
- Save time changing discs
- Ideal for grinding and cutting steel, stainless steel, aluminum, titanium, fiberglass and more



EB Cut Off Wheels – "Slicer" for cutting metal and more

Eco Brazing (EB) diamond cutting wheels from CS Unitec are designed for cutting steel and stainless steel pipe, tubing, bolts and plate, as well as composites, fiberglass and other materials.

Order No.	Size (dia. x arbor)	Grit	Max. Speed	Quantity
EBC4007850C	4" x 7/8"	50	13,000 RPM	1 disc
EBC4507830C	4-1/2" x 7/8"	30	13,000 RPM	1 disc
EBC4507850C	4-1/2" x 7/8"	50	13,000 RPM	1 disc
EBC5007850C	5" x 7/8"	50	13,000 RPM	1 disc
EBC6007830C	6" x 7/8"	30	8500 RPM	1 disc
EBC6007850C	6" x 7/8"	50	8500 RPM	1 disc
EBC7007850C	7" x 7/8"	50	8500 RPM	1 disc
EBC9007850C	9" x 7/8"	50	8500 RPM	1 disc



EB Combination (Grinding – Cutter) Wheels

Eco Brazing (EB) diamond combination metal grinding and cutting wheels from CS Unitec are designed for grinding and cutting steel and stainless steel bolts and plate.

Order No.	Size (dia. x arbor)	Grit	Max. Speed	Quantity
EB4007835CM	4" x 7/8"	35	13,000 RPM	1 disc
EB4007850CM	4" x 7/8"	50	13,000 RPM	1 disc
EB4507835CM	4-1/2" x 7/8"	35	13,000 RPM	1 disc
EB4507850CM	4-1/2" x 7/8"	50	13,000 RPM	1 disc
EB5007835CM	5" x 7/8"	35	13,000 RPM	1 disc
EB5007850CM	5" x 7/8"	50	13,000 RPM	1 disc
EB7007835CM	7" x 7/8"	35	8500 RPM	1 disc
EB7007850CM	7" x 7/8"	50	8500 RPM	1 disc

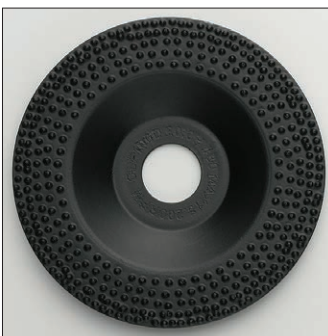

EB Cluster (Cleaning – Grinding) Wheels

Eco Brazing (EB) diamond cluster wheels from CS Unitec are designed for removing paint, rust and epoxy on metal. Also for high material removal on fiberglass, composites and plastics without loading up like traditional abrasives.

Order No.	Size (dia. x arbor)	Grit	Max. Speed	Quantity
EB4007880CLSF	4" x 7/8"	80	13,000 RPM	1 disc
EB4507880CLSF	4-1/2" x 7/8"	80	13,000 RPM	1 disc
EB5007880CLSF	5" x 7/8"	80	13,000 RPM	1 disc
EB6007880CLSF	6" x 7/8"	80	8500 RPM	1 disc
EB7007880CLSF	7" x 7/8"	80	8500 RPM	1 disc

PIPE-MAX

Pipe Belt Grinder

The PIPE-MAX is a combination grinder and pipe belt sander. The front hard rubber contact roller drives the abrasive belt to grind flat surfaces. It removes weld seams in a straight line, without leaving edges or a wavy finish.

For sanding pipes or handrails, it is a flexible tool. The sanding belt follows every contour to grind and polish up to a high-gloss finish. The belt wraps around the pipe and requires only a few steps to polish the entire circumference. It is ideal for stainless steel, aluminum and high-quality metals.



- For sanding pipes from small to large diameter, up to 14"
- Grinds weld seams on flat surfaces – leaves no edges
- Powerful 15 Amp motor and variable-speed control from 950 to 3500 RPM
- Quick and easy changing of sanding belts
- Ideal for stainless steel and aluminum



You can follow the external contour of the pipe diameter with light, uniform contact pressure. The new contour concept with the elastic return roller allows the grinding and polishing belts to conform around the external diameter of the pipes without great force.



1 Gas pressure cylinder allows belt to conform to contour of pipe with proper pressure.



2 Additional handle for comfortable, overhead working.



3 The drive roller with the rubber rings ensures that the grinding belts will not slip.



The soft grinding roller made of PUR material also allows comfortable longitudinal grinding of flat surfaces, for example to remove spot welds or eliminate deep scratches.

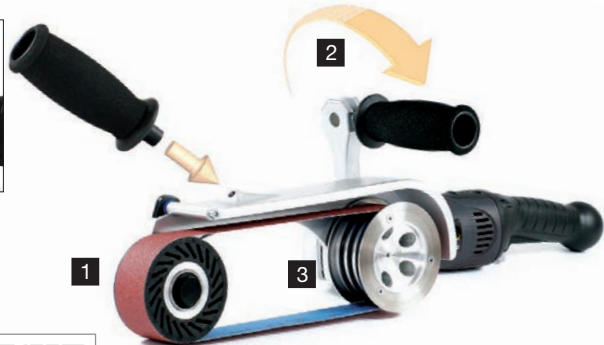

Pneumatic Pipe Sander also available. (LBR1506 AIR)
See price list for details.

PIPE-MAX Specifications

Part Number: 38502A	
Belt Size (L x W)	30.7" x 1.5"
Belt Speed	33 - 100 ft./sec.
Power	15 Amp (1710 Watts) 110V
Pipe ø Max.	14"
Weight	11.25 lbs.

Standard Equipment

1 PIPE-MAX basic machine, 110V	2 PIPE-MAX SC-fleece belts, medium
1 QUICK-LOCK cable, 13 feet	2 PIPE-MAX SC-fleece belts, fine
1 additional handgrip	3 spare rubber rings
PIPE-MAX grinding belts, 2 each grits 40, 60, 80 and 120	

220 Volt also available. *Note: Exact belt size is 780mm x 40mm.

PIPE-MAX Accessories

All PIPE-MAX Belts shown below: Belt Size – 30.7" x 1.5" (780mm x 40mm) • 10 belts per package

Abrasive Grinding Belts		Abrasive Surface Conditioning Fleece Belts		Abrasive Grinding Belts – Ceramic		TZ Pyramid Belts		SuperPolish Belt
Grit	Part No.	Grit	Part No.	Grit	Part No.	Grit	Part No.	Part No.
24	38523	Coarse (brown)	38531	24	38124	A100/220	38544	38850
40	38524	Medium (red)	38532	36	38136	A65/320	38545	
50	38525	Fine (blue)	38533	40	38140	A45/400	38546	
60	38526	Superfine (grey)	38534	60	38160	A30/600	38547	
80	38528			80	38180	A16/1200	38548	
120	38529			100	38100			

QUICK-LOCK Cable (Qty. 1) – Length: 13 ft. (standard, included)

BOA PIPE SANDER

Electric or Pneumatic

All-around polishing solution for handrails, pipe and tubing.



PIPE FINISHING AND POLISHING

The LRP 1503 BOA Pipe Sander is the perfect solution for sanding and polishing pipe constructions. The sanding arm snakes up to 270° around the radius of the pipe. The operator simply rotates the BOA slightly to achieve a full 360° finish. Spring resistance between the deflection rollers ensures that the sanding arm and belt are always uniformly tensioned. The BOA saves time finishing stainless steel and other ferrous and nonferrous pipe.

- Variable-speed control; 12 to 40 ft./sec. belt speed
- Maximum pipe Ø: 5" diameter
- Quick, tool-free replacement of sanding belt
- High-quality 270° sanding arm is made of light alloy with two deflection rollers for quick progress, perfect finish and simple operation
- Additional side handle can be rotated 180° in narrow spaces



LRP 1503 VRA with sanding belt

Electric or Pneumatic

BOA Accessories

Electric BOA Pipe Sander

Part Number: LRP 1503 VRA

Power	11 Amp
Belt Speed	12 - 40 ft./sec.
Belt Dimensions	30" x 1-1/2" or 3/4"*
Weight	8.2 lbs.

Pneumatic BOA Pipe Sander

Part Number: LRP 1503 AIR

Power	1 HP
Belt Speed	28 ft./sec.
Air Consumption	20 CFM @ 90 PSI
Weight	8 lbs.

Standard Equipment

1 carrying case with padding
1 abrasive grinding belt, grit 80, 30" x 1-1/2"
1 abrasive grinding belt, grit 120, 30" x 3/4"
1 abrasive grinding belt, grit 220, 30" x 3/4"
1 surface conditioning fleece, fine, 30" x 1-1/2"
1 surface conditioning fleece, medium, 30" x 1-1/2"
1 super polish belt, grit 600, 30" x 1-1/2"
1 super polish belt, grit 1500, 30" x 1-1/2"

* Note: Exact belt size is 760mm x 40mm or 20mm

Abrasive grinding belt (10/pkg.)

Size	Grit	Part No.
30" x 1-1/2"	24	326 706
30" x 1-1/2"	36	326 712
30" x 1-1/2"	60	326 723
30" x 1-1/2"	80	326 739
30" x 1-1/2"	120	326 755
30" x 1-1/2"	220	326 771
30" x 3/4"	120	326 801
30" x 3/4"	220	326 836

Surface conditioning fleece belt (3/pkg.)

Size	Grit	Part No.
30" x 1-1/2"	Coarse (brown)	326 895
30" x 1-1/2"	Medium (red)	326 879
30" x 1-1/2"	Fine (blue)	326 852

Sanding-Polishing Belt (1/pkg.)

For high-gloss polishing, without polishing agents, in two steps

Size	Grit	Part No.
30" x 1-1/2"	600	326 917
30" x 1-1/2"	1500	326 933

FINGER BELT SANDER *Variable Speed*

Ideal for angles and tight spaces, as well as pipes and curves. The swivel-mounted arm, with 140° flexibility, reaches into corners, grooves and folds.

The LBS 1105 VE finger belt sander saves time grinding in confined and difficult areas. It uses belt sizes 3/16" to 1-1/8" wide by 21" long. The sanding arm rotates up to 140° for reaching into corners, grooves and folds, including pipes and curves.

The finger sander is ideal for grinding, blending, polishing and deburring ferrous and nonferrous metal. It also works on wood, plastic, fiberglass and other material. Speed is adjustable from 13 to 39 ft./sec.



LBS 1105 VE with 3/8" sanding arm. Interchangeable 1-1/8" arm shown at right.



Finger Belt Sander Accessories

Abrasive Sanding Belt (10/pkg.)

Size	Grit	Part No.
3/16"	60	303 615
3/16"	120	303 623
3/8"	40	257 101
3/8"	60	257 105
3/8"	120	257 102
3/8"	220	257 103
1-1/8"	60	255 328
1-1/8"	120	255 329
1-1/8"	220	255 330

Surface conditioning fleece belt (3/pkg.)

Size	Grit	Part No.
3/8"	Medium (red)	318 663
3/8"	Fine (blue)	318 671
1-1/8"	Medium (red)	318 647
1-1/8"	Fine (blue)	318 655

SuperPolish Belt (1/pkg.)

For high-gloss polishing, without polishing agents, in two steps

Size	Grit	Part No.
1-1/8"	600	318 132
1-1/8"	1500	318 140

Optional Equipment

- (1) 3/8" sanding arm (curved) – Part No. 256 532
- (1) 1-1/8" sanding arm (large roller) – Part No. 258 888



Narrow filing arm and 140° adjustability allow sanding and grinding in confined and difficult areas.



Finger Belt Sander Specifications

Order No. LBS 1105 VE

Power	6.1 Amp
Belt Speed	13 to 39 ft./sec.
Weight	5.5 lbs.

Standard Equipment

- (1) 3/8" sanding arm (pointed) – Part No. 256 525
- (1) abrasive belt kit, grits 40/120/220 – 1 set
- (1) side handle – Part No. 194 034
- (1) hexagon socket screw key – Part No. 115 460

Standard equipment includes a metal carrying case.



Gladius® 1800 Multifunctional Grinder

Ideal for hard-to-reach areas such as corners, angles and tight spaces.

- Grind, deburr, blend and polish ferrous and nonferrous metals, wood and plastic
- Long, sword-shaped, belt-driven tool for finishing hard to reach areas
- Infinitely adjustable speed control from 1000 to 3800 RPM
- Tachogenerator provides constant speed, even under load
- Innovative design allows use of the full length of both sides of the arm for smooth grinding, blending and polishing
- Integrated dust extraction port reduces airborne particles when connected to an industrial vacuum



Gladius® 1800 Specifications

Part No. 38651A

Belt Size (LxW)	30.7" x 1.5"*
Power	15 Amp / 110V
Speed	1000 - 3800 RPM
Weight	10 lbs.

* Note: Exact belt size is 780mm x 40mm

The Gladius® 1800 uses the same abrasive belts as the PIPE-MAX. See page 30 for more information.

Gladius® 1800 Professional Kit

Part No. 38652A



Professional Kit includes:

- 1 Gladius® basic machine (110V)
- 1 QUICK-LOCK power cord
- 1 Machine stand (P/N 38660)
- 2 SC-fleece belts, medium grit (P/N 38532)
- 2 SC-fleece belts, fine grit (P/N 38533)
- 2 40 grit Zirconium abrasive grinding belt (P/N 38524)
- 2 60 grit Zirconium abrasive grinding belt (P/N 38526)
- 2 80 grit Zirconium abrasive grinding belt (P/N 38528)
- 2 120 grit Zirconium abrasive grinding belt (P/N 38529)
- 1 Aluminum carrying case (P/N 50102)

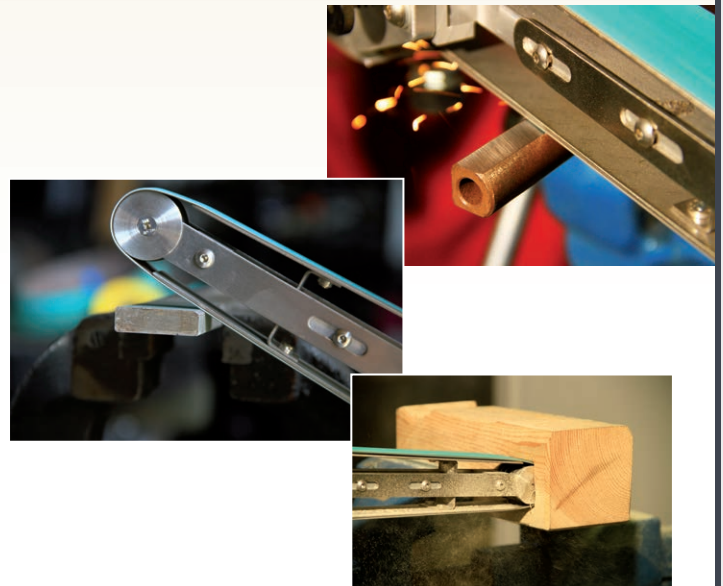

Convert the Gladius® 1800 to a bench-mounted grinder with optional machine stand for precision grinding and polishing.
Optional machine stand: Part No. 38660



Angle Grinders / Sanders with Dust Extraction

L 1506 VV 4" and 4-1/2", Electric
Extremely powerful 11 Amp angle grinder and sander with variable-speed electronic motor. Vacuum port: 1-1/4". Ideal for use with our **CS 1445 H**, **CS 1225** or **CS 1500** Dust Extraction Vacuum (see page 35).

L 1506 VV AIR 4" and 4-1/2", Pneumatic
Extremely powerful 1 HP angle grinder and sander with 1 HP pneumatic motor. Vacuum port: 1-1/4". Ideal for use with our **CS 1445 H**, **CS 1225** or **CS 1500** Dust Extraction Vacuum (see page 35).

Vacuum Port: 1-1/4"



L 1506 VV with dust extraction
(2200 to 6800 RPM)

5/8" Spindle
7/8" Arbor

L 1506 VV Specifications

Part Number:	L 1506 VV	L 1506 VV AIR
Power	11 Amp	1 HP
Speed	2200-6800 RPM	6000 RPM
Max. Diameter	4-1/2"	4-1/2"
Spindle Thread	5/8"-11 UNC	5/8"-11 UNC
Weight	4 lbs.	4 lbs.
Air Consumption	-	33 CFM @ 90 PSI
Air Connection	-	1/4"



Stepped Adapter (optional) adapts vacuum port to a 1-1/4" dia. hose
Part No. 5.453-016



L 1506 VV AIR
(6000 RPM)
(Hose not included)

5/8" Spindle
7/8" Arbor

TIPS & TRICKS

EASY-LOCK SPEED NUT SAVES TIME, WEIGHT AND MONEY!

Never has changing a grinding disc been so quick and efficient

The secret behind it – the self-clamping **EASY-LOCK SPEED NUT**

Part No. 65008-1 (5/8"-11 UNC)

The **EASY-LOCK SPEED NUT** allows abrasive discs to be changed in seconds without tools. The **SPEED NUT** works with any abrasive with a hemp or ABS backing plate and a 7/8" arbor. That means you can change abrasives on an angle grinder in a matter of seconds. It easily hand tightens and eliminates the need for wrenches or heavy, expensive 5/8"-11 hubs.

The clamping collar shape on the top of the **EASY-LOCK SPEED NUT** can secure flap discs and abrasives with a "thicker" backing disc as well as centering them. "Thin" abrasives such as cutting discs, etc. can simply be secured using the reverse of the **EASY-LOCK SPEED NUT** clamping nut.

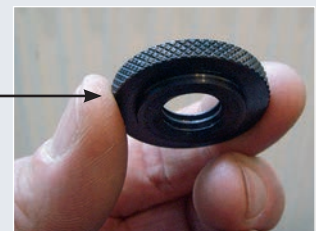

1. Secure the disc loosely by hand using the SPEED NUT.
2. Press the spindle lock and tighten the disc by turning it clockwise by hand. That's all there is to it!
3. To release the disc, press the spindle lock and turn the disc counter-clockwise by hand.

Dust Collection Vacuums with HEPA Filtration

CS Unitec's dust extraction vacuums offer strong 130 CFM air flow and an electromagnetic pulse filter cleaning system to maximize vacuum power and dust collection.

- Ideal for use with power tools
- 99.999% HEPA filtration efficiency of particles down to 0.3 microns; automatic filter cleaning
- "Power Take Off" outlet activates the vacuum ON/OFF from the power tool switch
- Non-HEPA models available, 99.930% filtration efficiency
- Kit available to connect two power tools (P/N 198804)

Activate vacuum on/off from power tool controls



Model CS 1445 H automatically "pulse" cleans filters without interrupting operation!



CS 1225 H



CS 1500

HEPA Vacuum Specifications

	CS 1225 H	CS 1500 H	CS 1445 H
Power	11 Amp	11 Amp	11 Amp
Air flow	130 CFM	130 CFM	130 CFM
Tank capacity	6.6 gal.	13 gal.	9 gal.
Weight	24.3 lbs.	35.2 lbs.	24.3 lbs.
Filter P/N (2pk.)	428956	428956	428956

Standard Vacuum Specifications

	CS 1225	CS 1500	CS 1445
Power	11 Amp	11 Amp	11 Amp
Air flow	130 CFM	130 CFM	130 CFM
Tank capacity	6.6 gal.	13 gal.	9 gal.
Weight	24.3 lbs.	35.2 lbs.	24.3 lbs.
Filter P/N (2pk.)	416069	416069	416069

Optional Filter Bags

Paper filter bags for CS 1225 and CS 1445

P/N 416014 (5-pack)

Plastic filter bags for CS 1225, CS 1445 and CS 1500

P/N 421742 (5-pack)

Paper filter bags for CS 1500

P/N 416021 (5-pack)

Slurry filter bags for CS 1500

P/N 420592 (3-pack)



We make no claim that use of a vacuum will eliminate contaminants. Wear an approved respirator mask and follow all appropriate OSHA safety regulations for proper ventilation, dust handling, eye protection, etc. when using a dust extraction grinder and vacuum.

ROLEI® BE 5 Sheet Metal Deburring Machine – 2 Speeds

Double-sided deburring of sheet metal up to 0.2" thick can be achieved in a single operation with no additional treatment. The machine's flap wheels can be easily adjusted as they wear. One set of wheels lasts for approximately 6500 feet of stainless steel sheet. Supplied standard with two 80 grit flap wheels, the ROLEI® BE 5 can be used with other optional grits to suit the facet width and materials of your particular application.



Features two-speed operation:

- Speed 1: fine deburring, 600 RPM
- Speed 2: standard deburring, 1200 RPM

Optional accessories:

- Spare flap wheels (40, 60, 80, and 120 grit)
- Machine stand, made from strong steel
- Port for industrial dust extractor (Part No. 30330)

ROLEI® BE 5 Specifications

Part Number:	30310A (220 Volt) 30310 (380 Volt)
3-Phase Motor	220V 3-phase / 2 speeds .2 KW / .9 Amp 380V 3-phase / 2 speeds .2 KW / .45 Amp
Dimensions	19.7" x 12.8" x 7.9"
Weight	64 lbs.
Options	Machine stand, dust extractor connection port, teflon tape

ROLEI® BE 5 Flap Wheels

Part No.	Grit	Qty.
37040	40	2 discs per pack
37060	60	2 discs per pack
37080	80	2 discs per pack
37120	120	2 discs per pack

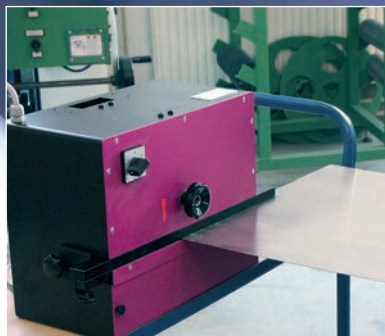
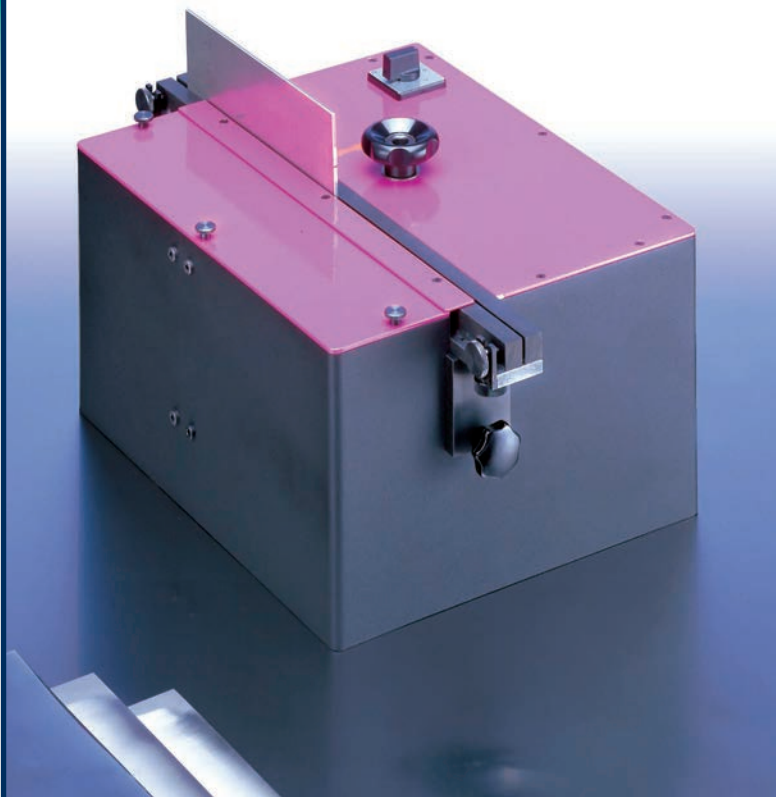

Can also be used on its side with roller tables for large thin sheets.

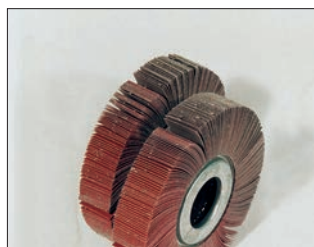
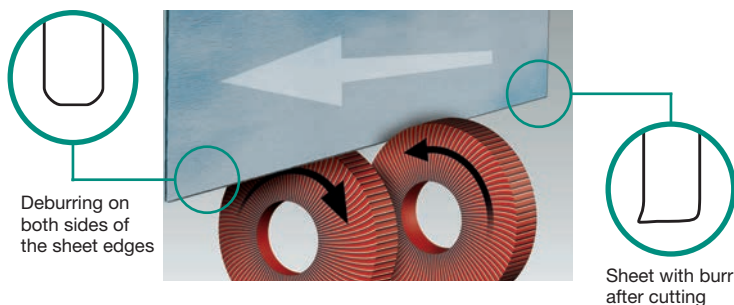

Spare flap wheels for sheet metal deburring machine BE 5
Grit 40, 60, 80, 120



Machine stand - Part No. 30320
Strong steel machine stand with black powder coating



Dust extraction port (end and bottom views shown above)
Part No. 30330



Teflon protective tape – self-adhesive (2 required)
Part No. 30341 (27.5" L x 3/4" W)
For extension rail to protect from scratching the workpiece

ROLEI® EF 115 Hand-held Deburring and Faceting Machine

This handy deburring machine is designed for awkward, heavy parts, such as machine tables, frame constructions or large sheets of metal. Easy to handle, with good edge control. The EF 115 is also ideal for chamfering welds. Fixed beveling angle of 45°, infinitely adjustable facet width from 0" to 3/8".

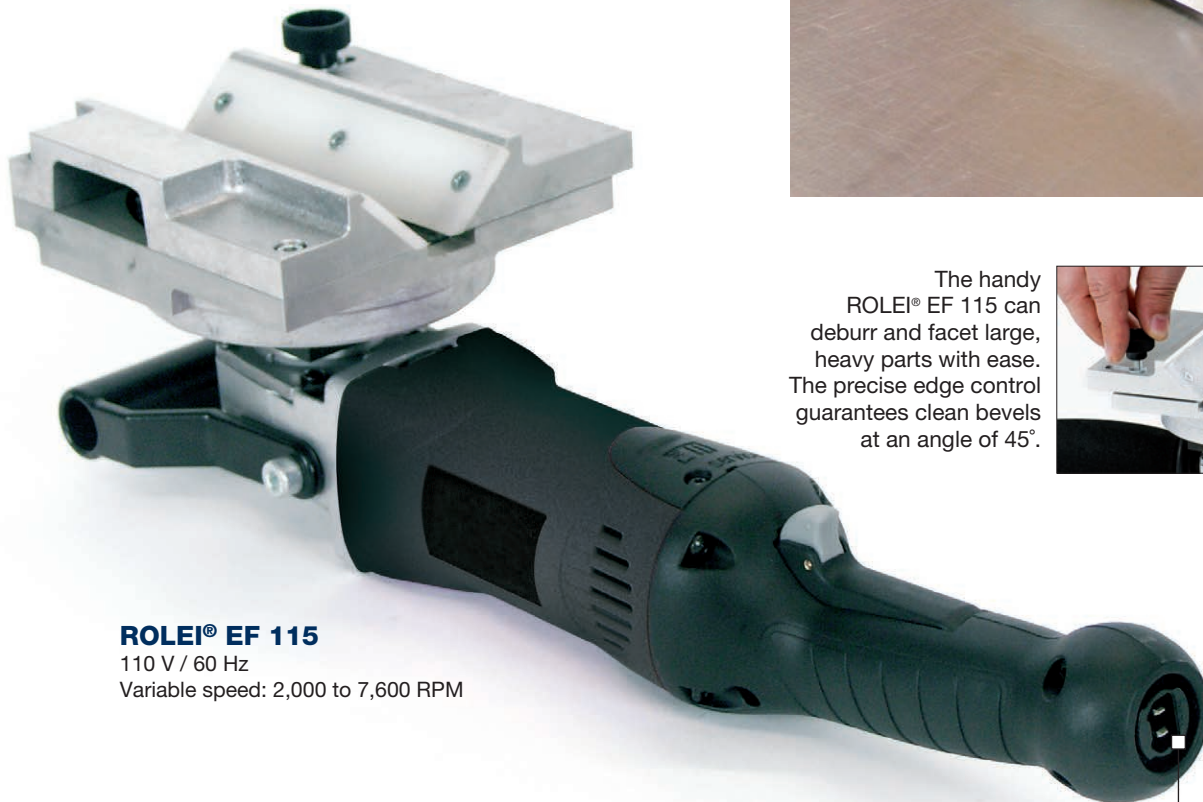

ROLEI® EF 115
110 V / 60 Hz
Variable speed: 2,000 to 7,600 RPM

The handy ROLEI® EF 115 can deburr and facet large, heavy parts with ease. The precise edge control guarantees clean bevels at an angle of 45°.



QUICK-LOCK cable for fast, easy replacement, e.g. if the cable is damaged. 13 ft., included.

ROLEI® EF 115 Specifications

Part Number:	30116
Universal Motor	15 Amp (1710 W) 110V / 60 Hz (230V / 50 Hz, 1600 W also available)
Speed	Infinitely adjustable from 2,000 to 7,600 RPM
Weight	9 lbs.
Options	Sliding guide rail, plastic (Part No. 30117, 2-piece set)

ROLEI® EF 115 Flap Discs

Part No.	Grit	Quantity
21050A	50	10 discs per pack
21060A	60	10 discs per pack
21080A	80	10 discs per pack
21120A	120	10 discs per pack

Simple disc changing.

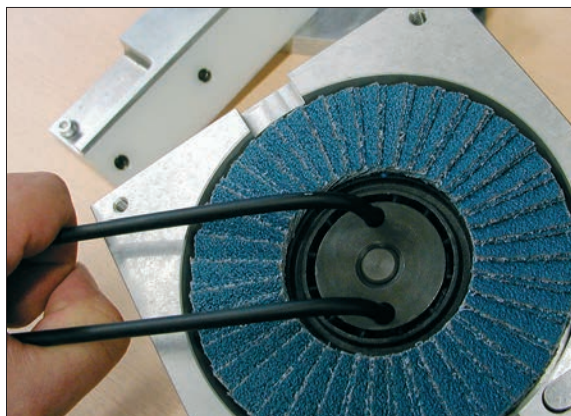

ROLEI® EF 165

Beveling and deburring machine for facets at an angle of 45°.

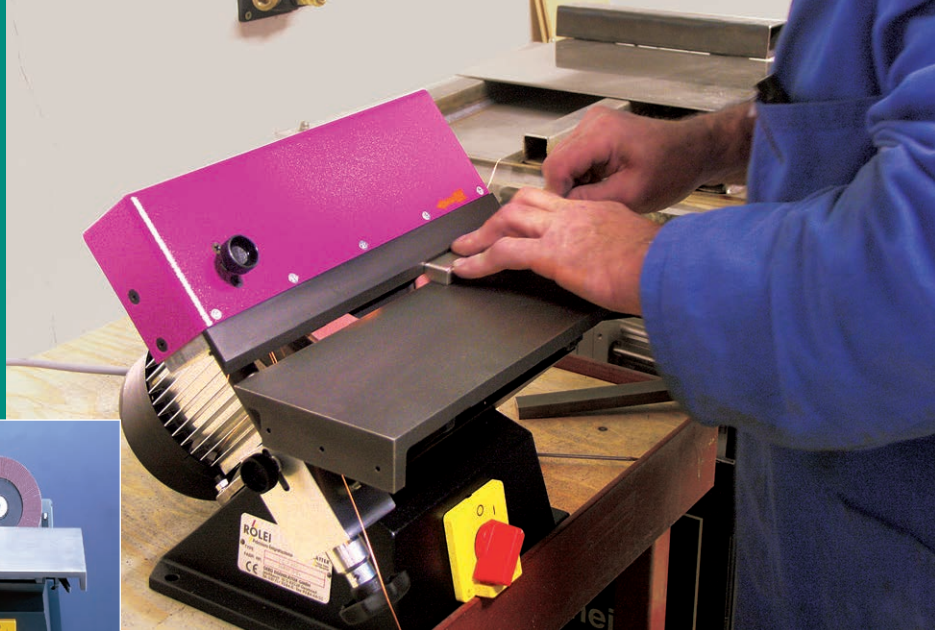

Optional dust extraction port
Part No. 30130

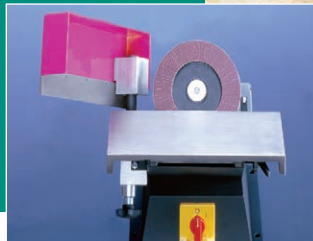

Beveling and deburring machine with a fixed beveling angle of 45° and an infinitely adjustable beveling width from 0" to 3/8" for all metals from stainless steel to aluminum. Precise adjustment of the face width using a hand wheel.

Optional accessories:

- Table extension (2 pieces, 5" x 13" each)
- Machine stand
- Extraction port for industrial dust extractor
- Spare flap discs (60, 80, 120 grit)



Machine stand
Part No. 30120
Sturdy steel machine stand with black powder coating.



Extended support table
Part No. 30110
Made of sliding grey cast material.
27-1/2" long



Spare flap discs
The flat disc with special hard compression for deburring machines. Self-sharpening and extremely long service life!

- 60 Grit Part No. 36060
80 Grit Part No. 36080
120 Grit Part No. 36120

ROLEI® EF 165
Speed: 2800 RPM

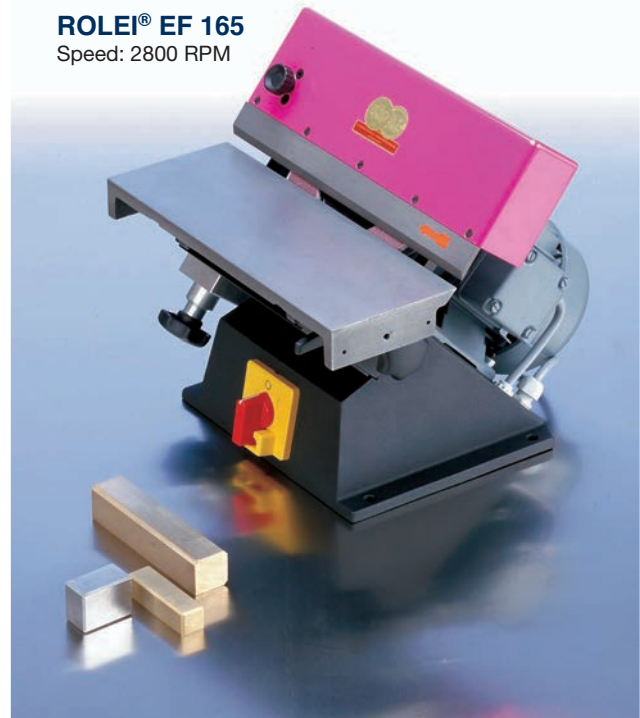

ROLEI® EF 165 Specifications

Part Number:	30101 (220 Volt) 30100 (380 Volt)
Motor	220V single-phase or 380V, 3-phase
Dimensions	14" x 13" x 12"
Support Table	5" x 13"
Weight	40 lbs.
Options	Table extension, machine stand, extraction port for dust extractor connection

Supplied as standard with 80 grit disc. Other grits can also be used to suit the face width and materials.

ROLEI® PEF 500

Beveling and deburring machine for facets at angles of 30° to 60°.

Precision beveling and faceting machine for all metals from stainless steel to aluminum. Infinitely adjustable beveling angle from 30° to 60° and infinitely adjustable face width from 0" to 3/8" (precise adjustment using knob).

Optional accessories:

- Extraction port for dust (Part No. 30230)
- Sliding feed plate, plastic (Part No. 30210)
- Replacement flap discs (see below right)

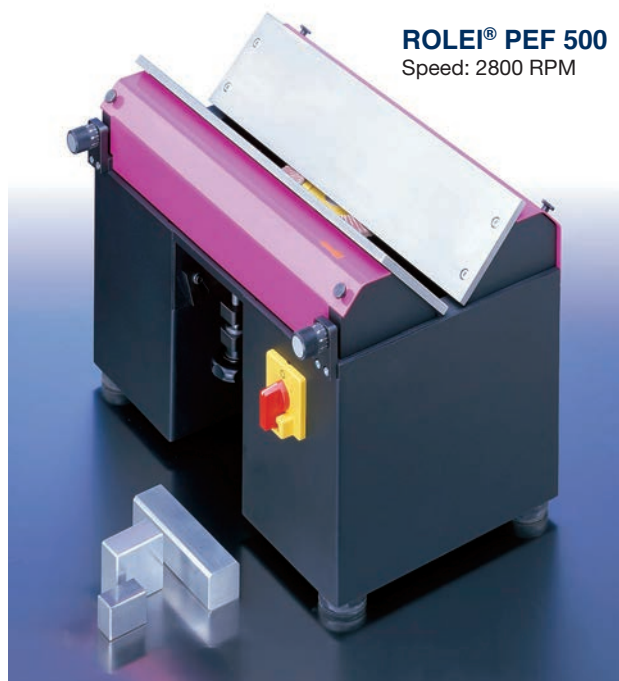

ROLEI® PEF 500
Speed: 2800 RPM

ROLEI® PEF 500 Specifications

Part Number:	30201 (220 Volt) 30200 (380 Volt)
Motor	220V single-phase or 380V, 3-phase
Dimensions	20" x 14" x 14"
Weight	88 lbs.
Options	Machine stand, extraction port for dust extractor connection

Supplied as standard with 80 grit disc. Other grits can also be used to suit the facet width and materials.

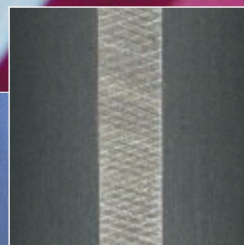
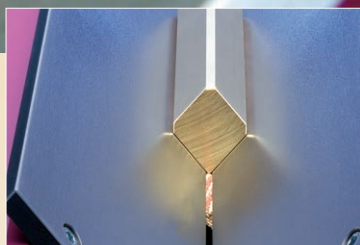

Parts are beveled with perfect cross-grinding – absolutely no opposite burr.



The face width can be adjusted precisely using a hand wheel.



The disc wear is adjusted using a hand wheel with a threaded spindle. The face angle can be adjusted using a motorized system.

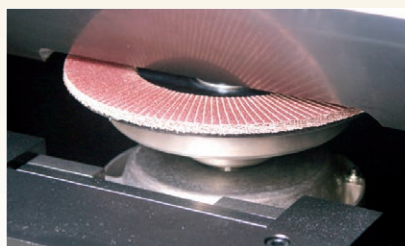

The easily interchangeable flat flap disc produces a chamfer which creates zero opposite burr.

- Replacement flap discs**
 60 Grit [Part No. 36060](#)
 80 Grit [Part No. 36080](#)
 120 Grit [Part No. 36120](#)



Infinitely adjustable facet angle from 30° to 60°

Multipurpose Beveling Machine

Bevel, deburr and chamfer edges of steel plate faster and cleaner than angle grinders.

The EKF multipurpose beveling machine is designed to bevel 30° or 45° weld seams on steel, stainless steel, nonferrous metals, brass and plastics. It can also be used to deburr and chamfer; straighten edges, internal and external radii; and countersink holes from 7/8" diameter.

- Fine adjustment feature for slight chamfers when deburring for the preparation of weld seams
- Three milling head options – 30°, 45° and 2.5mm
- Ideal for the following applications: **Moldmaking** (straighten edges, internal and external radii and countersink holes from 7/8" dia.); **Boiler and process plant construction** (prepare weld seams on heat exchangers); **Mechanical engineering** (deburr machine parts, chamfer edges to protect against paint peeling and create visible edges); **Sheet metal** (deburr cut edges)



Fine adjustment
Precise control of chamfer when deburring for weld seam preparation

Portable Beveler Specifications

Part Number:	EKF 300.3	EKF 450.3	EKF452.3
Beveling angle*	30°	45°	2.5mm
Bevel width (max.)**	1/4"	1/4"	1/4"
Motor power/Voltage	13.5 Amp / 110V (220 V / 50 Hz also available)		
Cutting speed	3000 SFPM		
Cutting inserts	3		
Dimensions (L x W x H)	12-1/2" x 5-1/2" x 11-5/8"		
Weight	10.5 lbs.		

* EKF milling heads are interchangeable.

** Max. bevel width may require several passes, depending on material hardness.

One Machine, Three Milling Options

30°	45°	R 2.5 radius
EKF 300.3	EKF 450.3	EKF 452.3
Milling cutter 30°, Chamfer 0 - 1/4"	Milling cutter 45°, Chamfer 0 - 1/4"	Milling cutter 2.5mm radius (optional)



Cutting Plates - Sold as pack of 10
Part No. **SHM 200:** 30° and 45°
Part No. **SHM 200-E:** 30° and 45° for stainless steel
Part No. **SHM 202:** 2.5mm radius

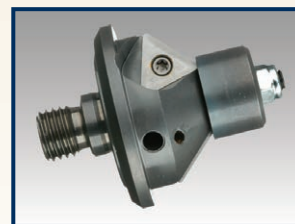

Standard equipment includes milling head and two inserts, SW22 key, carrying case and user's manual. Please see our Price List for available accessories.

SKF Beveling Machine for Plates and Pipes

Fast, easy preparation of weld seams and bevels on plate or pipe.

- Bevel 15° to 60° angles and land width up to 3/4" on steel, stainless steel, aluminum and nonferrous metal plates and pipe
- Work on welding angles and weld preparation on pipes/tubes with a minimum OD of 6-1/4" (160mm) with built-in pipe roller guide; ideal for beveling pipe 6-1/4" OD and larger
- Robust design, single operator control and easy handling
- Anti-vibration system for operator comfort



SKF 25

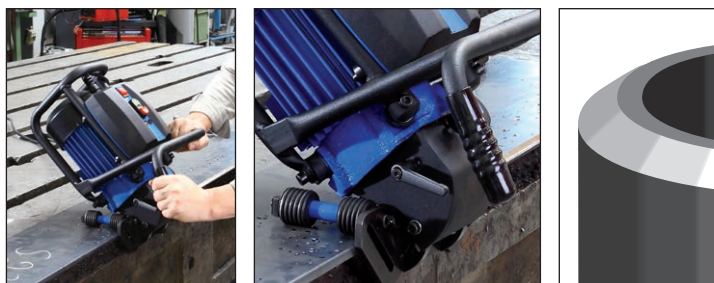

Standard equipment includes one milling head, 12 sintered carbide reversible cutting inserts, tools for assembly, built-in pipe roller guide, steel carrying case and user's manual. Please see our Price List for available accessories.

Cutting Plates - Sold as pack of 20
Part No. **SHM 800**; for beveling carbon and stainless steel

Portable Beveler Specifications

Part Number: SKF 25	
Beveling angle	15° - 60°
Bevel width (max.)**	3/4"
Motor power	10 Amp
Voltage	110V (220V / 50 Hz also available)
Cutting speed	1800 SFPM
Cutting inserts	12
Dimensions (L x H)	16-1/2" x 13"
Weight	43 lbs.

** Max. bevel width may require several passes, depending on material hardness

AutoCUT 500 Automatic Edge Processing Machine

Powerful, self-guiding beveling machine for 15° to 60° edges on plate up to 1.5" thick.

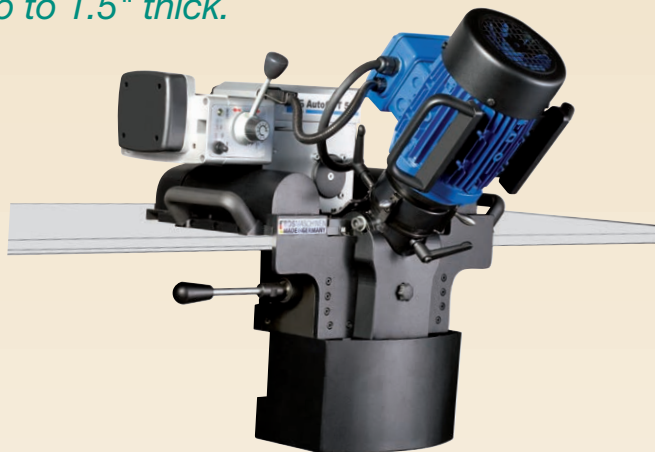

- Bevel 15° to 60° angles and land width up to 1-3/16" on steel, stainless steel, aluminum and nonferrous metal plates and pipe
- Unit propels itself on the plate, no need for a cart or stand
- Automatic feed and return
- Reversible carbide cutting inserts

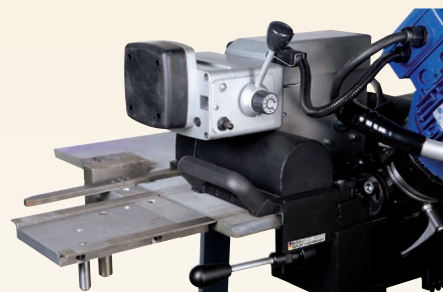
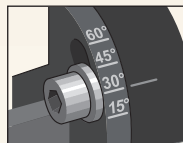
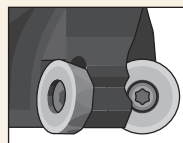

Automatic Edge Processing Machine Specifications

Part Number: AutoCUT 500	
Beveling angle	15° - 60°
Bevel width (max.)**	1-3/16"
Motor power	10 Amp
Voltage	230V, 3- phase
Cutting speed	2750 SFPM
Cutting inserts	6
Dimensions (L x W x H)	23-1/2" x 24" x 20-1/2"
Weight	110 lbs.

** Max. bevel width may require several passes, depending on material hardness

Surface Preparation Equipment

Electric and air power for the preparation of concrete, steel and stone.

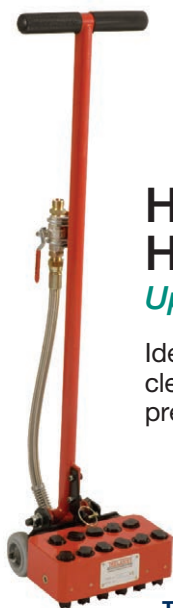

CS Unitec now offers even more innovative electric and pneumatic equipment for the preparation of steel, concrete and stone. These tools are ideal for industries, including: construction, floor preparation, utilities, marine & offshore, oil & gas, and nuclear decommissioning/remediation, as well as restoration, refurbishment and demolition.

Contact us for more information about our new line of surface preparation equipment.

Hand-held ScaleForce Scaling Hammers and Deck Hammers

Up to 33,000 blows per minute

Ideal for breaking down the hardest of coatings prior to abrasive blast cleaning, reducing cost of blast media and increasing surface preparation productivity. Widely used in the marine industry for removing rust, scale and paint from ship decks, as well as to descale tanks, bridge decks and floating platforms. Low vibration for operator comfort. Options include spark-resistant replacement heads for use in potentially hazardous environments and vacuum shroud to reduce dust.



Trelawny™ ScaleForce

Peening Preparation Tools – Hand-held Scarifiers

Clean, economical alternative to small-area shot blasting



Rotopeen™

The PPT line of handheld scarifiers use 3M™ Heavy-duty Rotopeen™ captive shot flaps or steel cutters for surface preparation. These units are ideal for the removal of alkyds, mastics, adhesives and coatings corrosion from a range of steel and concrete substrates. When part of a dust collection system, these tools more safely remove hazardous materials such as lead-based paints and contaminated particles quickly and cleanly.



Floor Scarifiers – Gas, Electric and Pneumatic

Remove rust, scale, paint, adhesives and more from steel and concrete



CS Unitec's Trelawny™ Floor Scarifiers tackle the most demanding surface preparation and material removal applications. Ideal for the removal of coatings and corrosion from steel and concrete surfaces to prepare for re-coating. Produce an ideal keyed or grooved profile on concrete for waterproofing and non-slip surface applications. Available with 8" and 10" cutting widths.



Needle/Chisel Scalers

Trelawny™ original Vibro-Lo™ low-vibration scalers

Lightweight, easy-to-handle pneumatic units provide up to 3000 blows per minute to remove coatings, corrosion and other accumulated materials. Ideal for all surfaces, especially irregular surfaces that are otherwise difficult to prepare. Also used for chipping, weld dressing and brick/stone cleaning. Optional in-line dust control systems to maintain worksite/environment cleanliness.



Portable Magnetic Drills

Fast, accurate hole cutting... on the job site or in the shop!

CS Unitec's portable magnetic drills are ideal for drilling structural steel and virtually any metal. We offer a compact, powerful and reliable range of portable magnetic drills for holes up to 5-1/8" diameter.

Cut up to 5-1/8" • Twist Drill up to 1-3/4" • Tap up to 1-5/8"

Unique features of CS Unitec's portable magnetic drill line:

- Variable-speed, multiple-gear models
- Reversible motors for tapping and machining
- Swivel base stand for hard-to-reach areas
- Manual or automatic feed
- Lightweight – from 24 lbs.



PORTABLE METAL CUTTING TOOLS - MAGNETIC DRILLS & SAWS



MAB 1300

ø 5-1/8" cutter capacity
ø 1-3/4" twist drill capacity
ø 1-5/8" tapping capacity
Reversible, 4-gear motor
The ultimate in power

NEW! MAB 825 V
with Automatic and Manual Feed

AutoMAB 350

ø 1-1/2" cutter capacity
Automatic feed, reverse and shut-off



MABasic 200

ø 1-3/8" cutter capacity
ø 1/2" twist drill capacity



Twist Drilling
Reaming



Tapping
Countersinking



Annular Cutters available for burr-free finished holes, without predrilling or step drilling

Dry Cutting Saws – Electric and Pneumatic

Fast, portable, burr-free cutting of metal plates, pipes, profiles and more... without coolant

Air power – ideal for petrochemical, marine, demolition and fabrication industries



Super Hand-held Dry Cut Saw

Model 8320 SHDC

Blade dia. – 12-5/8"
Max. DOC – 4-3/4"
Order No. 608270 U

Premium Super Dry Cutter

Model 9435

Blade dia. – 14"
Max. DOC – 6" at 90°
Order No. 608302



Model 5 1117 0020

Blade dia. – 12-5/8"
Max. DOC – 4-3/4"

Model 5 1116 0020

Blade dia. – 7-1/2"
Max. DOC – 2-1/2" at 90°

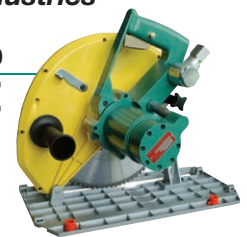

Model 5 1115 0020

Blade dia. – 9"
Max. DOC – 3-1/4" at 90°



Blades and Guide Rails available to meet your application needs.

For more information, visit our website at www.csunitec.com/saws/dry-cutting-circular-saws



• 1-800-700-5919 • Visit our Web site at www.csunitec.com

Also Available from CS Unitec

CS Unitec, Inc. specializes in industrial power tools and safety tools for construction and industry.

Innovation and high quality are synonymous with CS Unitec's power tools. In 1991, the company invented the first pneumatic portable band saw. CS Unitec has added to its list of industry firsts with the widest range of portable magnetic drills and hand-held concrete core drills. The line also includes surface preparation tools for metal, concrete and masonry, air, electric and hydraulic portable band saws, reciprocating saws, hack saws, nut runners, rotary hammer drills, rolling motors, non-sparking safety tools, portable mixers and dust extraction vacuum systems.

For tool specifications and ATEX and Ex Zone information, visit www.csunitec.com.

Call 1-800-700-5919 or 203-853-9522 to request any of the catalogs shown below.

UNITEC ... the power of innovation!®



View demo videos at www.csunitec.com



Contractor Tools:
Surface Preparation Tools, Concrete Grinders, Dust Collection Systems, Diamond Core Drills, Air Concrete Saws and more

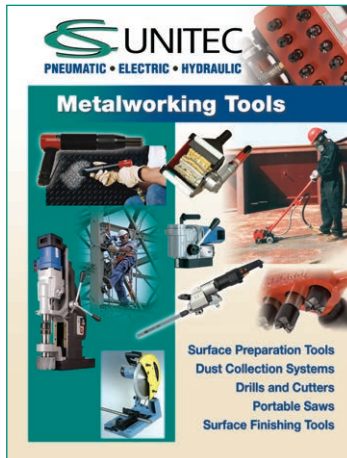

Metalworking Tools:
Surface Preparation Tools, Dust Collection Systems, Dry Cutting Portable Saws, Portable Magnetic Drills, Bridge Reamers and more

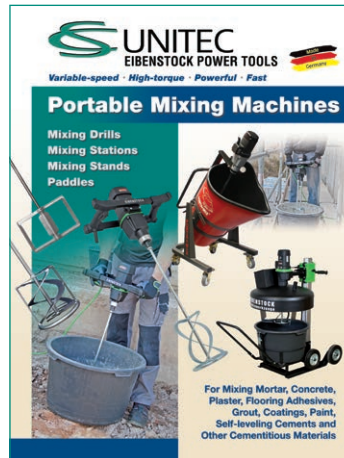

Portable Mixers:
Portable Mixing Machines for Mortar, Concrete, Plaster, Flooring Adhesives, Grout, Coatings, Paint, Self-leveling Compounds and more

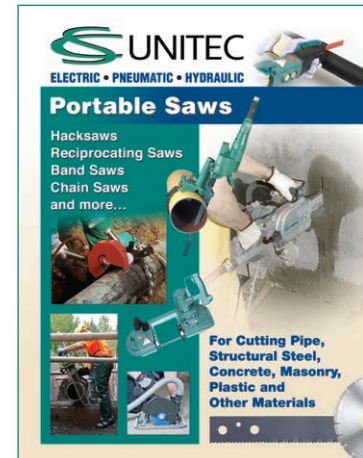

Portable Saws:
Hacksaws, Reciprocating Saws, Band Saws, Chain Saws, Cut-off Saws and more



Portable Magnetic Drills:
Magnetic Drills & Accessories, Hand-held Drills and Drive Units, Nut Runners, Hammer Drills and more



Surface Finishing Tools:
High-performance tools and accessories for grinding, sanding, polishing, deburring and beveling stainless steel, steel, nonferrous metals, wood and more

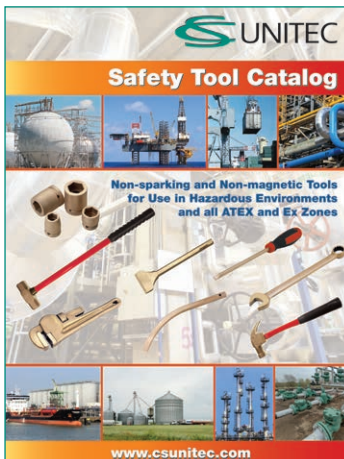

Non-sparking Hand Tools:
Non-sparking Hand Tools, Power Tools for use in Ex Zones, ATEX Zones and Hazardous Environments



Concrete & Masonry Tools:
Power tools for the professional contractor to drill, cut, grind and smooth concrete, masonry, wood, drywall and more – includes dust collection tool systems



CS UNITEC, Inc.
22 Harbor Avenue, Norwalk, CT 06850
Phone 800-700-5919 • 203-853-9522 • Fax 203-853-9921
Email info@csunitec.com • www.csunitec.com

View product demonstrations at www.csunitec.com.

ALL SPECIFICATIONS ARE SUBJECT TO CHANGE

© Copyright 2016, CS Unitec, Inc., 10-16-5M